

SENKO

PELLET STOVES for central heating

P 12 WATER+AIR | 13 kW

P 12 SLIM WATER+AIR | 13 kW

P 20 WATER+AIR | 19 kW

INSTRUCTION MANUAL



P 12



P 12 SLIM



P 20

For a perfect
warm home!

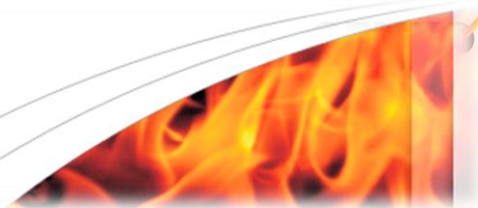

Dear client, thank you for choosing a SENKO pellet stove!

This product was designed and manufactured to its minutest details in order to fulfil your every need for functionality and safety.

This *Instruction manual* will teach you to operate your stove properly, so please read the manual carefully before using the stove.

SENKO management





This pellet stove is designed according to the following Directives:

- **89/106 EEC** ⇒ *Construction Products Directive*
- **89/366 EEC** } ⇒ *Electromagnetic Compatibility Directive*
- **2004/108 EEC** } }
- **2006/95 EEC** ⇒ *Low Voltage Directive*

And according to the following standards:

- **EN 14785** ⇒ *Room heaters fired by wood pellets*
- **EN 60335** } ⇒ *Safety of household and similar electrical appliances*
- **EN 62233** } }
- **EN 61000** } ⇒ *Electromagnetic compatibility*
- **EN 55014** } }

Symbols used in this *Instruction manual* :

- ATTENTION 
- WARNING 
- SAFETY 
- ADVICE AND RECOMMENDATIONS 

CONTENTS

| | |
|---|-----------|
| GENERAL | 4 |
| 1. WARNINGS AND SAFETY | 6 |
| 1.1. SAFETY DEVICES | 10 |
| 2. PELLETS..... | 11 |
| 3. TECHNICAL FEATURES | 12 |
| 4. INSTALLATION | 15 |
| 4.1. RECOMMENDATIONS | 15 |
| 4.2. PROPER INSTALLATIONS | 18 |
| 4.3. IMPROPER INSTALLATIONS | 18 |
| 4.4. CONNECTING TO OUTDOOR AIR | 18 |
| 4.5. CONNECTING TO CHIMNEY | 20 |
| 4.5.1. FLUE PIPES | 20 |
| 4.5.2. CHIMNEY | 25 |
| 4.5.3. CHIMNEY PREPARATION AND CONTROL | 26 |
| 4.5.4. CHIMNEY CAP | 27 |
| 4.5.5. CHIMNEY FUNCTION | 29 |
| 4.6. CENTRAL HEATING SYSTEM CONNECTION | 30 |
| 4.6.1. INSTALLATION TESTING | 33 |
| 4.6.2. RECEIVING AND MAINTAINING THE INSTALLATION | 34 |
| 5. HANDLING THE STOVE | 34 |
| 5.1. PRE-IGNITION WARNINGS | 34 |
| 5.2. LOADING THE PELLETS | 36 |
| 5.3. CONTROL PANEL | 36 |
| 5.4. REMOTE CONTROL | 38 |
| 5.5. BEFORE FIRST SWITCHING ON | 39 |
| 5.5.1. DATE AND TIME MENU | 42 |
| 5.5.2. WATER TEMPERATURE MENU | 43 |
| 5.6. IGNITION / SHUT DOWN | 44 |
| 5.7. OPERATING MODE | 46 |
| 5.7.1. MANUAL MODE (<i>MANU</i>) | 46 |
| 5.7.2. AUTOMATIC MODE (<i>AUTO</i>) | 47 |

| | | |
|------------|---|-----------|
| 5.7.3. | ECO MODE (<i>ECO</i>) | 48 |
| 5.7.4. | WARM AIR FAN (<i>FAM</i>) | 49 |
| 5.8. | ADVANCED FUNCTIONS | 50 |
| 5.8.1. | AUTOMATIC SHUT DOWN (<i>SLEEP</i>) | 50 |
| 5.8.2. | TIMER (<i>CHRONO</i>) | 50 |
| 5.8.2.1. | WEEKLY PROFILES | 53 |
| 5.9. | SETTINGS | 54 |
| 5.9.1. | BACKLIGHTING | 54 |
| 5.9.2. | PELLET FEEDER CORRECTION (<i>PELLET RECIPE</i>) | 55 |
| 5.9.3. | PELLET FEEDER FILLING (<i>CHARGE PELLET</i>) | 57 |
| 5.9.4. | BURNER POT CLEANING (<i>CLEANING</i>) | 57 |
| 5.10. | TECHNICAL MENU (<i>SERVICE</i>) | 57 |
| 5.11. | USER INFO MENU | 57 |
| 5.12. | ALARMS..... | 58 |
| 6. | CLEANING AND MAINTENANCE | 61 |
| 6.1. | BURNER POT | 61 |
| 6.2. | ASH PAN | 62 |
| 6.3. | DOOR GLASS | 63 |
| 6.4. | EXTERNAL SURFACE | 63 |
| 6.5. | PELLET TANK | 64 |
| 6.6. | FIREBOX DOOR GASKET | 64 |
| 6.7. | CENTRAL FLUE GAS CHANNEL | 64 |
| 6.8. | OUTPUT FLUE GAS CHANNEL | 66 |
| 6.9. | INPUT PRIMARY AIR CHANNEL | 66 |
| 6.10. | FIREBOX | 67 |
| 6.11. | ELECTRONIC COMPONENTS | 68 |
| 7. | MALFUNCTIONS / CAUSES / SOLUTIONS | 70 |
| 8. | TECHNICAL SUPPORT | 72 |
| 9. | TECHNICAL DATA | 73 |
| 10. | TERMS OF WARRANTY | 74 |
| | WARRANTY SHEET | 75 |
| | INSTALLATION REPORT | 76 |
| | CE MARKING | 77 |

GENERAL

- E 2404 pellet stove for central heating P 12 WATER+AIR
- E 2405 pellet stove for central heating P 20 WATER+AIR
- E 2406 pellet stove for central heating P 12 SLIM WATER+AIR

are models from the SENKO pellet stoves palette which can best accommodate your space heating needs. Therefore, we ask you to CAREFULLY READ THESE INSTRUCTIONS, which will help you to achieve the best possible results already during the initial use. **The manufacturer is not responsible** for any consequences (people or animal injuries or property damages) resulting from **failure to comply with this Manual**.



The stove is hot during operation and the use of protective heat insulated gloves is compulsory during handling.



Children and infirm individuals are not allowed to handle the stove.

The external appearance of the stove is shown on the first page of this Manual. When ordering the stove or the spare parts, it is necessary to state its full designation, for example: E 2405 P 20 WATER+AIR, colour PC-3.

SIDE WALL COLOUR PALETTE:

- BORDEAUX → **PC-2**
- CREAM → **PC-3**
- ANTHRACITE GREY → **PC-7**

Pellet stoves are manufactured in accordance with the EN 14785:2006 norm and comply with all the requirements set by the norm.

The stove is packaged on a EURO pallet. During transport, the stove must be properly fastened in order to prevent tumbling or damages. The standard delivered stove set consists of:

- A) Pellet feeder motor;
- B) Flue gases suction ventilator;
- C) Warm air distribution ventilator (*below the pellet tank*);
- D) Motherboard with control panel;
- E) Remote control + power supply cable;
- F) Burner pot;
- G) Keys for stove service and maintenance;
- H) Ash pan;
- I) PVC regulation feet with screw
(*not supplied for P12 SLIM stove*);
- J) Instruction manual;
- K) High-efficiency circulation pump („ErP ready“);
- L) Closed expansion tank (6L-stove P12, 8L-stove P20);
- M) Safety valve R1/2" (2,5 bar);
- N) Valve R1/2" for filling/emptying the boiler;
- O) Automatic vent valve (*at the highest point of the boiler, beneath the left side wall*).

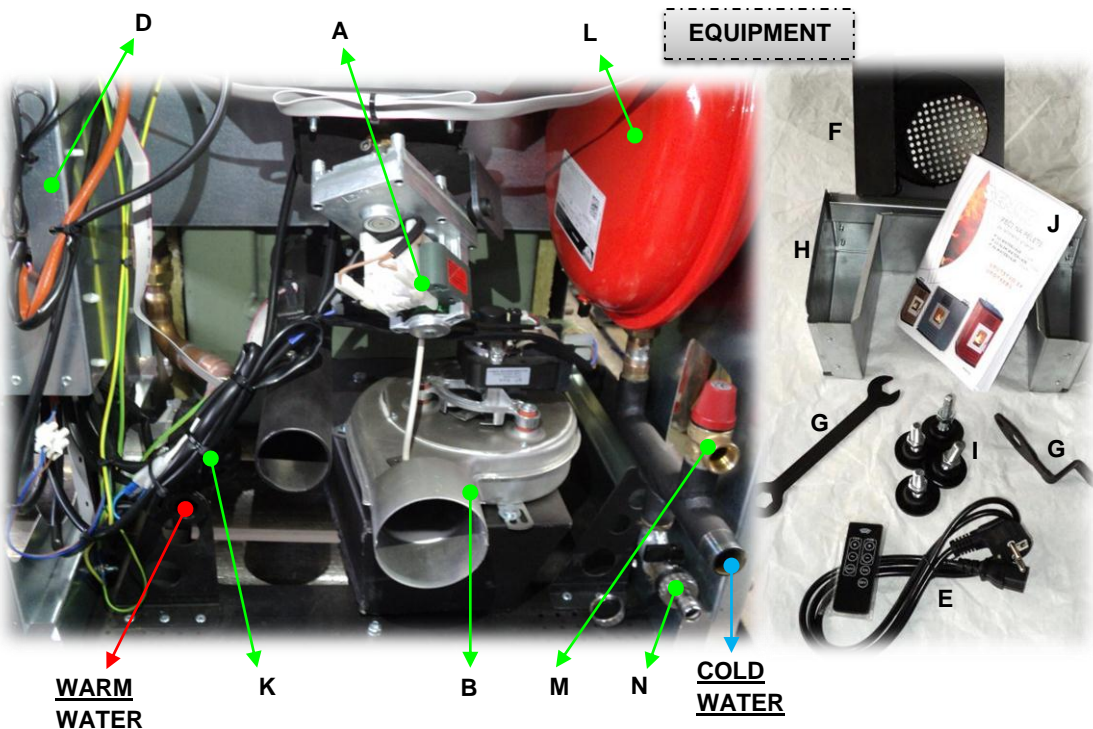
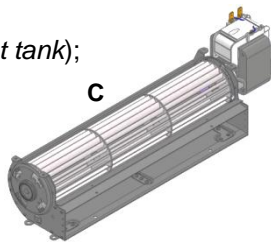

CAUTION! The stove weighs over 250 kg. Extra caution is necessary when unloading, transferring, moving and installing the stove in order to avoid physical injury.



1. WARNINGS AND SAFETY

SENKO pellet stoves are constructed in accordance with all the security measures prescribed by EN 14785 norm. Attention paid to every stove component assures safety from potential accidents for both the user and the fitter.

Our recommendations:

- a) **Prior to undertaking any operation on the stove the user is OBLIGATED TO READ AND COMPREHEND this *Manual*.**
- b) It is necessary to turn off the stove (the switch must be in position 0) and unplug the electric cable before any operation on the stove.
- c) During any operation on the stove, special attention must be paid to electric connections, especially bare conduit sections, which must not, in any way, leave the wire grips, thus avoiding direct contact with the conduit.
- d) **The stove must not be installed in rooms with gas stoves or cookers, in bathrooms, laundry objects or similar.** The same applies **for rooms and apartments which are vented via air facilities or hot air heating facilities with fans (air conditioning, kitchen hoods and similar), UNLESS** such facilities have safety devices which unfailingly prevent occurrence of underpressure of 4 Pa in the room where the furnace has been installed, i.e. rooms connected with external air.
- e) **The stove can be installed in a residential space and basement with normal air humidity and temperature from +5°C to +25°C** (temperature of the surrounding area at the stove in operation).
- f) **A pellet stove is not resistant to moisture and MUST NOT BE installed in moist rooms!**
- g) **In spaces where the temperature is less than 5°C (holiday house) it is necessary to ensure that the stove is working at**



minimum power or on the ECO mode (see *chapter 5.7.3.*). In central heating systems it is necessary to infuse the antifreeze into the system.

- h) At room temperatures above 25°C, the safety systems on the stove can be activated.



- i) **Due to stove operation and flame sound, it's not recommended to install the stove in bedrooms and relaxation rooms.**



- j) **For your own safety, DO NOT LEAVE THE STOVE TO OPERATE DURING THE NIGHT WITHOUT SUPERVISION!**



- k) The room, in which will be the pellet stove installed, must be large enough to prevent overheating of the stove → **the minimum volume of the room, in which will be the pellet stove installed, must be 4 m³ per kW of stove nominal power!**



- l) In the room in which the stove is located you should always have installed additional heating devices (eg. radiators, underfloor heating, etc ...). This is especially important in the transitional period (autumn / spring), when the stove is not in use, but you use heat from other energy sources (solar, biomass, etc.) in combination with a water storage tank (buffer). Then such heating is sufficient, but you need a heating device which will warm up the space.

- m) **It is necessary to adhere to all European, national and local regulations (norms) applicable in the country of product installation.**



- n) **The manufacturer is not responsible for any consequences (people or animal injuries or property damages) resulting from failure to comply with this Manual.**



- o) This Manual is an important part of the product, and is therefore necessary to ensure it is kept next to the product, especially in cases the product is handed over to a different owner or relocated.

- p) This stove is intended for central heating and may not be used for different purposes. Upon removing the protective foil from the stove, inspect it for damages and missing parts. Should anything be missing, contact the vendor you purchased the stove from.
- q) Prior to commencing the firing procedure, the stove **MUST be connected to the chimney and central heating system!**
- r) **Connecting the stove to the central heating system must only be carried out by authorized service personnel. Servicer that connects the stove to the central heating system must guarantee the correctness of the system.**
- s) **Never use any flammable liquids for ignition of pellets!**
- t) **Do not leave the pellet bag in contact with a hot stove!**
- u) All stove parts enable good and proper functioning of the stove and, when necessary, must be replaced by original spare parts made exclusively by the manufacturer (failure to install original parts results in void warranty!)
- v) In order to maintain product functionality and to protect it, **regular stove maintenance** must be executed in accordance with the Manual (at user's expense) depending on pellet consumption (for stove P12 → 1000 kg of pellets or 2000 hours of operation, for stove P20 → 2000 kg of pellets or 2000 hours of operation) **but at least once a year**. Maintenance technician must provide the **certificate of executed stove control and maintenance** (should you not possess such a certificate, your product warranty becomes void). ⇒ **see chapter 5.10.**
- w) **Use only pellets certified** in accordance with the following norms: EN 14961-2, Ö-Norm M 7135, DIN 51731 or ENplus-A1.



It is also necessary to mention:

- **All stoves before shipment may be activated and tested.**
- It is **FORBIDDEN** to dry a laundry in front of a decorative front grille



- Do not touch the stove with wet or moist body parts and ensure that the product is always plugged to a properly grounded socket.
- **The stove is hot during operation and the use of protective heat insulated gloves is compulsory during handling (opening and closing of firebox door, removing the ash pan and similar).**



- It is forbidden to alter safety rules without the permission or instructions by the manufacturer.
- Do not pull out, remove or bend electric cables from the stove even if the stove has been disconnected from the power grid.
- Avoid plugging or reducing the dimensions of air supply opening in the room where stove has been installed. Air supply openings are necessary for proper combustion. Minimum combustion air opening is 10 cm x 10 cm (or a hole with approximate diameter of 12 cm).



- **During regular stove operation, firebox door must be closed at all times.**
- Control possible primary air supply and flue gases channels for possible clogging before activating the stove after a long period of inactivity of the stove.



- Following repeated attempts to turn on the stove, accumulated non-combusted pellets must be removed from the firebox prior to subsequent attempt.

- **Pellet tank lid must be closed at all times.**



- **In case of chimney fire, turn off the stove, unplug the power supply cable, close primary air inlet and don't open the firebox door. Extinguish the fire using appropriate fire extinguishers. **NEVER EXTINGUISH A FIRE WITH WATER!** In case of fire also call the local fire department. Comply with local regulations for fire protection!**



- If you lose this Manual, you can get a copy from SENKO Company or its authorized representative. You can also find it at <http://en.senko.hr/>

1.1. SAFETY DEVICES



SENKO pellet stove consists of the following safety devices:

- **Motherboard** ⇒ intervenes directly and activates the alarm until the stove completely cools off in operating conditions which deviate from the pre-set safety conditions ;
- **Fuse** ⇒ protects the stove from sudden changes in electricity voltage (max.6,3 A and 250 V) - see *Figure 47* ;
- **Pellet tank temperature safety probe** ⇒ in the case of too high pellet tank temperature (max.110°C), the probe automatically blocks pellet feeding and activates the alarm **A03** ;
- **Water tank temperature safety probe** ⇒ in the case of too high boiler water temperature (max.95°C), the probe automatically blocks pellet feeding and activates the alarm **A18** ;
- **Flue gases temperature measurement probe** ⇒ in case of excessive flue gases temperature (max.180°C) the probe automatically resets the stove to normal temperature values (minimum power – level 1, i.e. *fire 1* on the control panel) OR activates the alarm **A04** ;
- **Room temperature measurement probe** ⇒ in case of higher room temperature from the set point the probe automatically resets the stove to normal temperature values (minimum power – level 1, i.e. *fire 1* on the control panel) - see *Figure 33a* ;
- **Water temperature measurement probe** ⇒ in case that the water temperature increases above 85°C, the probe automatically resets the stove to normal temperature values (minimum power – level 1, i.e. *fire 1* on the control panel) ;
- **Primary combustion air flow measurement probe** ⇒ in case of insufficient (or excessive) chimney diameter, this probe automatically regulates (to a certain level) the speed of flue gases ventilator, i.e. primary air flow, in order to achieve optimum fuel combustion in the firebox.

2. PELLETS

Pellets are pressed wooden waste (sawdust and similar) obtained by mechanic pressing in special machines. Apart from being an **ecological fuel**, pellets also have a technical advantage over other wooden biomass – **they have the highest calorific value and very low humidity** (10% max).



The pellets you use **must be certified** in accordance with **EN 14961-2, Ö-Norm M 7135, DIN 51731** or **ENplus-A1** norm.



How to determine pellet quality?

- They must be cylindrical with a constant diameter and must have a shiny surface!
- Their diameter must be **5 - 6 mm** and their length **10 - 40 mm!**
- There must not be too much sawdust or dust in the packaging!
- The packaging must be hermetically sealed (due to potential exposure to moisture)!
- The pellets must break, but not crack!
- Put a handful of pellets into a water container. If the pellets are good quality, they will sink to the bottom, otherwise they will float!



- **Pellets must be stored in dry conditions!**
- **Use of low quality pellets or any other fuel adversely affects the functionality of your stove and can result in void warranty and annulment of manufacturer responsibility!**



3. TECHNICAL FEATURES

SENKO pellet stove WATER is constructed for the purpose of heating residential buildings, but also to serve as a piece of decorative element in any surroundings. Stove centre and load bearing construction are made from steel sheets.

Internal part of the firebox (boiler) is made of highly resistant quality boiler sheet according to EN 14785. Firebox is equipped with door with fire resistant glass. This solution provides an aesthetically pleasing visual effect of flame in the firebox, simultaneously preventing the egress of ash and smoke into the heated area.

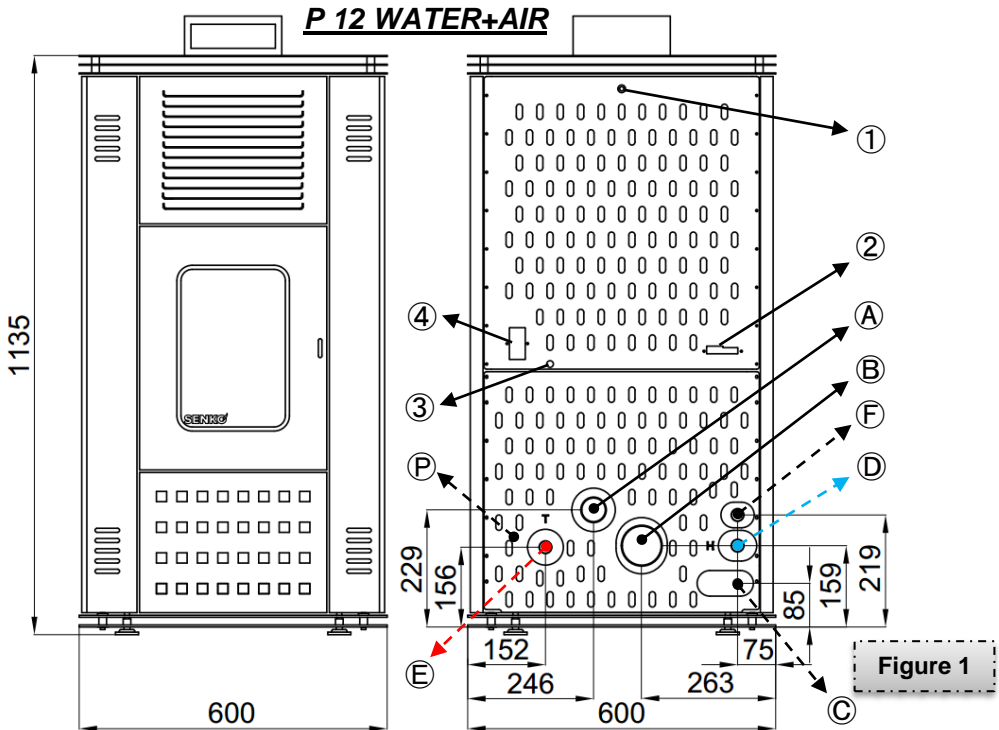

Figure 1

THE KEY:

- ① Bar for closing / opening the pellet tank lid (see Figure 19)
- ② Port for connection to PC / GSM modem / room thermostat (see Figure 33a)
- ③ Room temperature measurement probe (see "P" on Figure 33a)
- ④ Switch 0/1

- (A) Ø 50 mm – primary air inlet
- (B) Ø 80 mm – flue gases outlet
- (C) R1/2" F – valve for boiler filling / emptying
- (D) R3/4" M (P 12) / R1" M (P 20) – cold water
- (E) R1" M / (E)* R3/4" M – warm water
- (F) R3/4" F – safety valve (2,5 bar)
- (P) Circulation pump (behind the side wall)

P 12 SLIM WATER+AIR

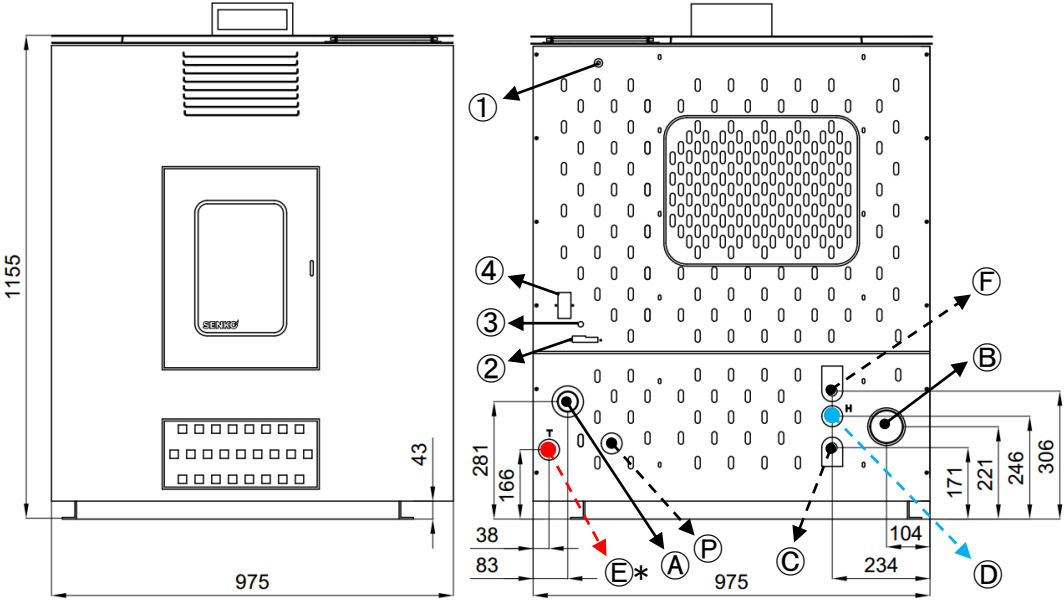
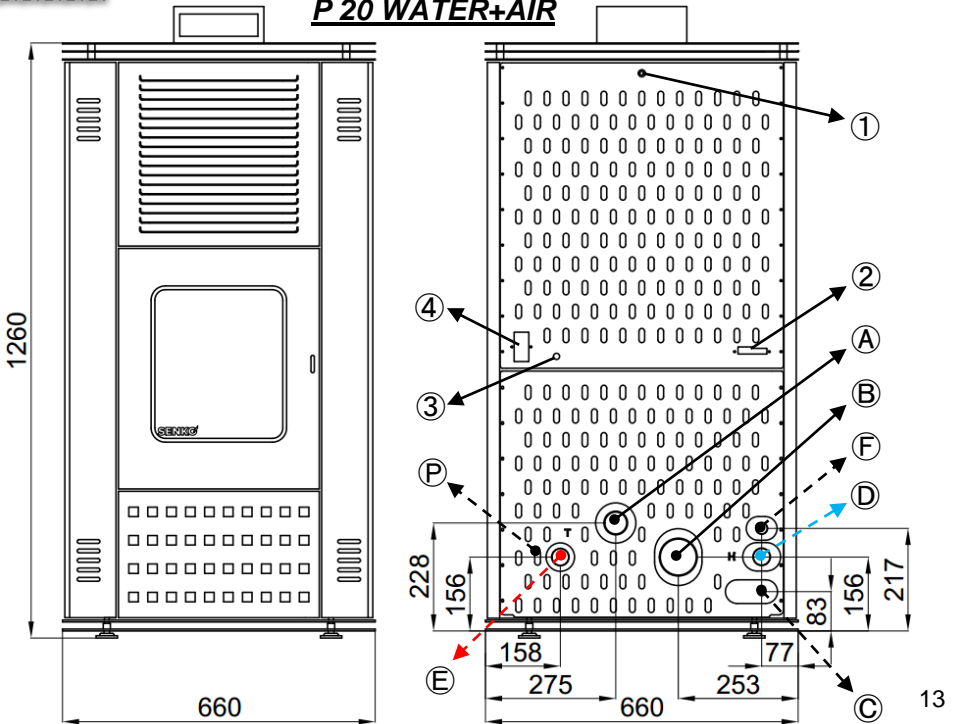

Figure 1

P 20 WATER+AIR



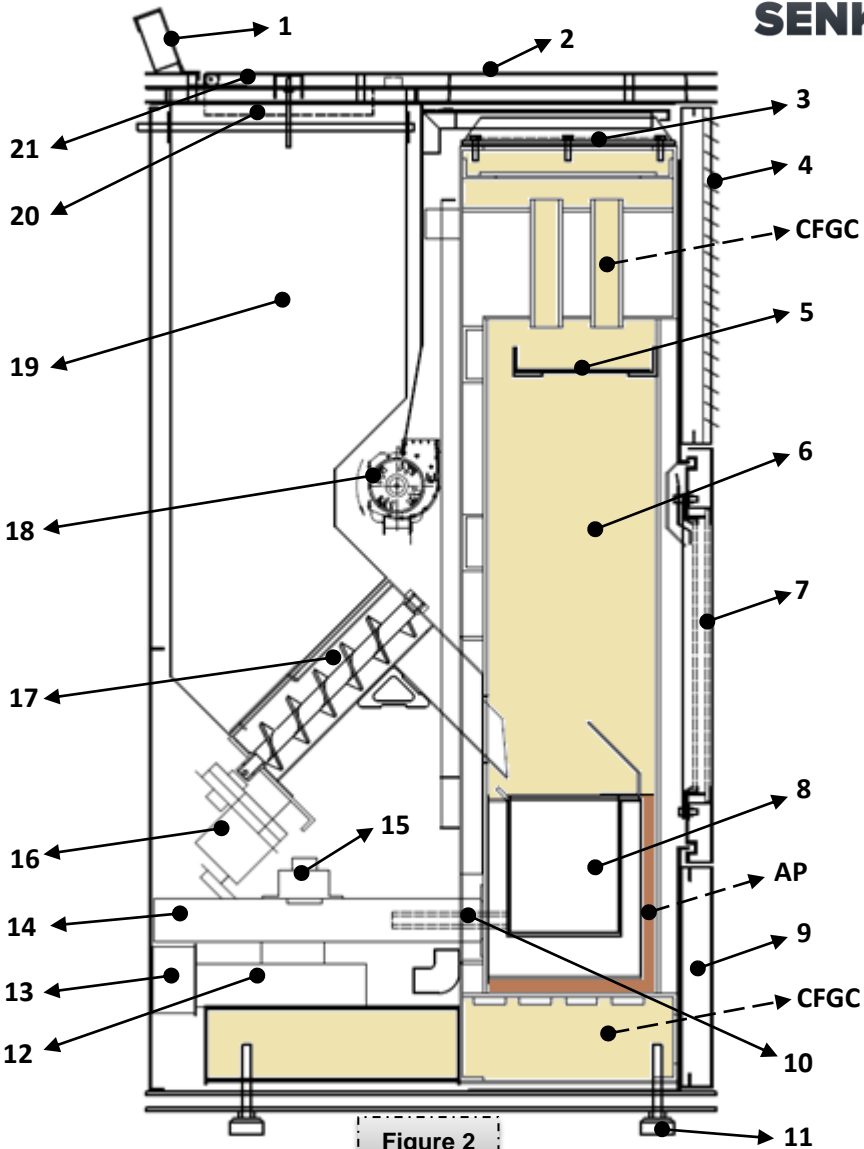

Figure 2

THE KEY:

- 1. Control panel
- 2. Cleaning hatch lid
- 3. Flue gas lid
- 4. Top protective sheet
- 5. Firebox plate
- 6. Firebox
- 7. Firebox door glass
- 8. Burner pot

- 9. Lower protective sheet
- 10. Pellet igniter
- 11. Base with screws for height adjustment
- 12. Flue gases fan
- 13. Chimney connection Ø80mm
- 14. Connection Ø50mm for outside (primary) air inlet

- 15. Airflow sensor
- 16. Pellet feeder motor
- 17. Pellet feeder
- 18. Warm air fan
- 19. Pellet tank
- 20. Pellet tank grid
- 21. Pellet tank gasket

AP – ash pan (see *chapter 6.2.*)
CFGC – central flue gas channel (see *chapter 6.7.*)

4. INSTALLATION

4.1. RECOMMENDATIONS

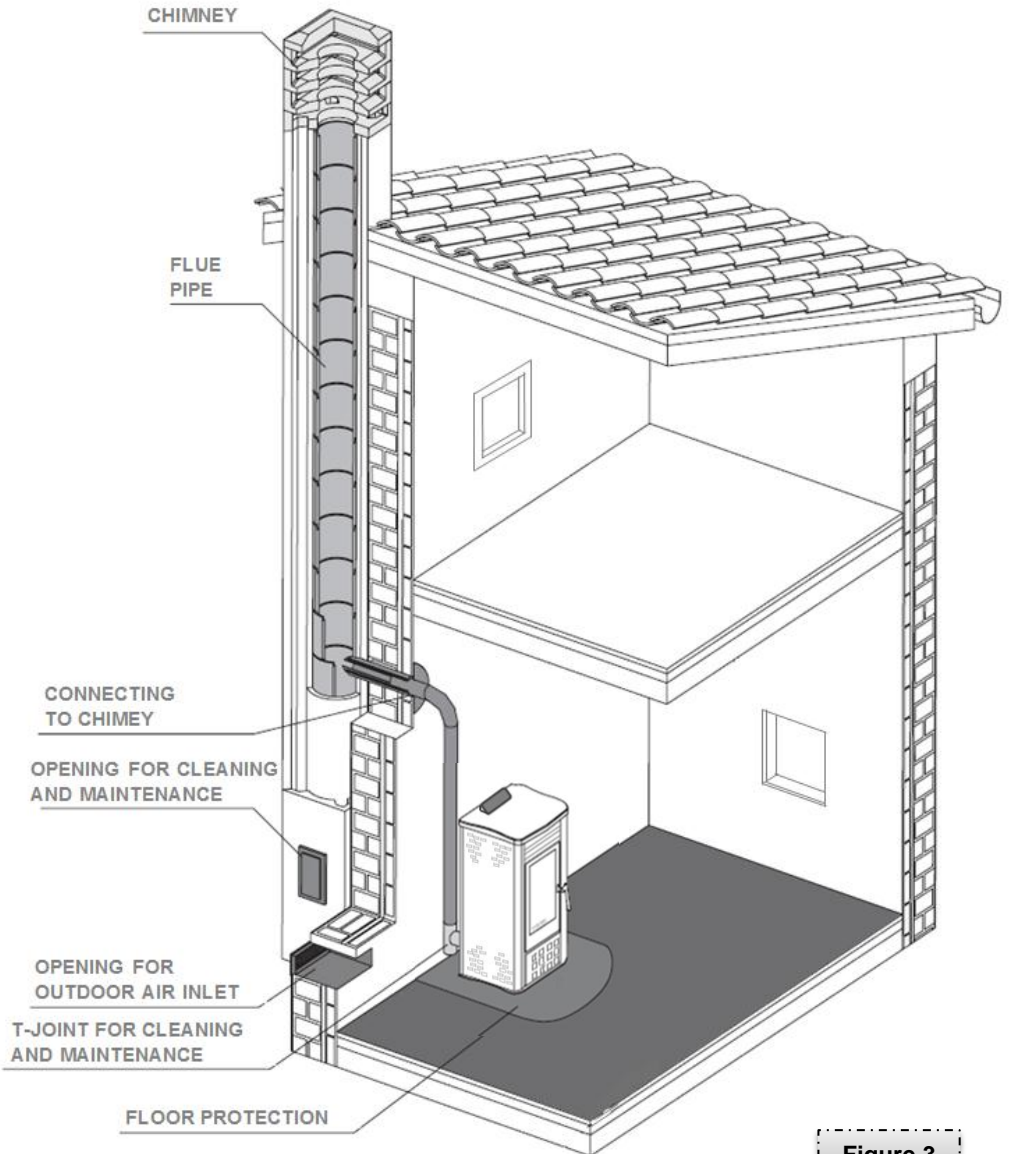
**Figure 3**

We advise you **to check** the following elements **prior to installation**:

- Appropriate minimum volume of space where the stove will be installed (avoid placing the stove into hollow or narrow spaces under 40 m³ of volume);
- Ensure suitable and proper exchange of primary air necessary for combustion via connection with external air;
- Proper execution of chimney and smoke venting pipes.



Prior to installation it is necessary to **control** proper **positioning** of the stove and the chimney, which must comply with:

- Prohibitions concerning the installation;
- Safety distances;
- Limitation prescribed by the local administrative regulations or special safety measures prescribed by the authority;
- **It is not allowed to install the stove in rooms where another heating device without the autonomous air exchange already exists.**
- **It is forbidden to install the stove in the room with explosive atmosphere.**



| | |
|----------|---|
| A | 200 mm from the back wall |
| B | 200 mm from the side wall |
| C | 800 mm from the front grid |
| D | 500 mm floor protection |
| E | 300 mm (measured from the maximum angle of firebox door opening) |

Table 2

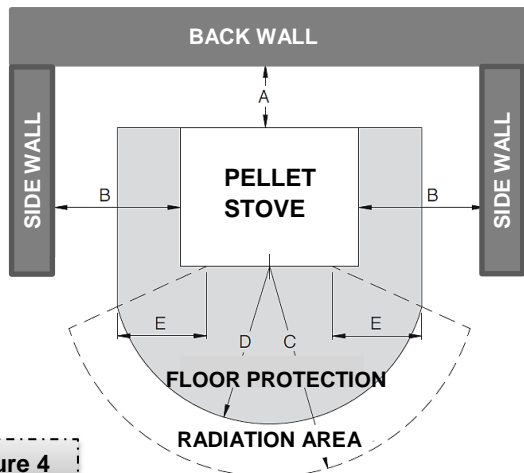

Figure 4



Adjoining walls must be constructed of brick or concrete, or other non-flammable materials, i.e. protected with insulation. The stove emits heat, especially on the firebox level, therefore, **no flammable or heat sensitive objects must be placed nearby** (for example, alcohol, paper, plastic objects...).



The stove must be installed with adherence to minimum prescribed measures and constant control of the **safety distance from the walls and the furniture** (figure 4). If the floor is made of flammable material (e.g. wooden parquet) it must be protected with a single plate made of non-flammable material which must be placed under and around the stove to prevent floor overheating problems (figures 3 and 4 – floor protection).

| | Flammable objects | Non-flammable objects |
|----------|-------------------|-----------------------|
| A | 200 mm | 100 mm |
| B | 1500 mm | 800 mm |
| C | 300 mm | 200 mm |

Table 3

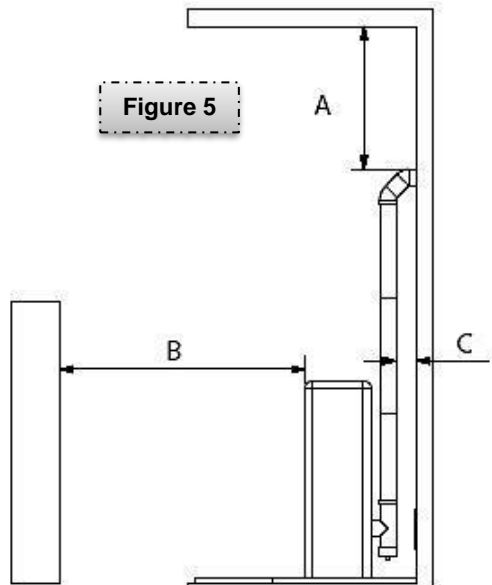

We recommend to install the stove as close to the smoke venting pipe as possible, limiting the number of roundings to a minimum (max 3 + inspection and cleaning T-piece) and chimney horizontal parts (**max total 3 m with a 3-5° incline**) ⇒ see 4.5. *Connection to chimney.*

4.2. PROPER INSTALLATIONS

Only devices that function as a closed system (close chamber) or don't create underpressure with regard to the external ambient may be installed or already exist in the room where the stove is to be installed.



Installation of food processing devices and kitchen hoods without suction is allowed only in rooms used as kitchens.

4.3. IMPROPER INSTALLATIONS

Devices that **must not** exist nor may be installed in the rooms where the stove will be installed are:

- kitchen hoods, air-conditioning devices;
- collective type ventilation pipes.



When the afore mentioned devices are located in the adjoining rooms, which are in contact with the room where SENKO pellet stove is installed, it is forbidden to use these devices simultaneously in cases where there is a risk that underpressure will occur in one of the two rooms with regards to the other.

4.4. CONNECTING TO OUTDOOR AIR

For proper stove function and good distribution of heat it is necessary to position the stove in a place where there is an opening for intake of external (primary) air necessary for pellet combustion or where one can be constructed. **Minimum opening surface must be 100 cm²** (figures 6a, 7). The opening must be constructed to prevent any form of clogging (**protected by grid, metal mesh or appropriate protection**).





Air may also be supplied from adjoining rooms (figure 6b). It is important that these rooms are in constant free supply of external air. Adjoining room must meet all the criteria listed above with regard to the installation room and must not be used as a bedroom, bathroom or any space where fire may occur (e.g. garage, woodshed, flammable material storage room and similar).

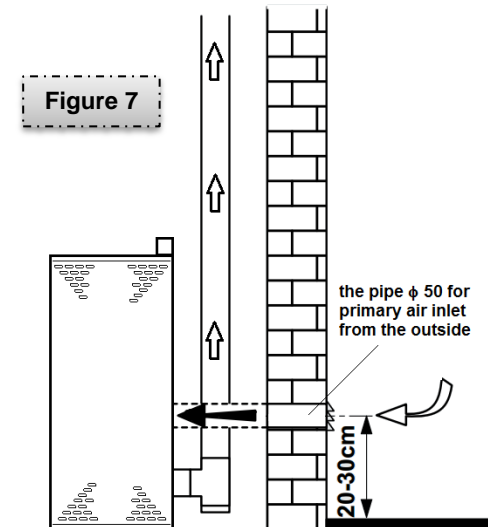
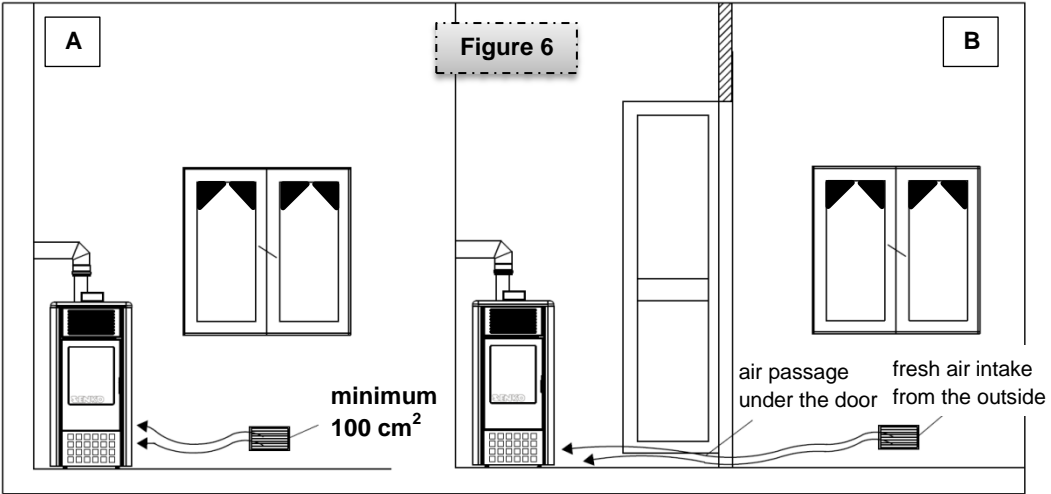

If the air necessary for combustion is sucked via pipes directly from the external environment, a round pipe in a 90° downward incline must be installed outside, equipped with a protective grid, due to birds, mice and potential accidental clogging.

Air can be supplied from external environment through external air connection ($\varnothing 50$ on the stove backside) via pipe, up to 3 m long maximum (it must be taken into account that each 90° elbow matches 1 linear meter).

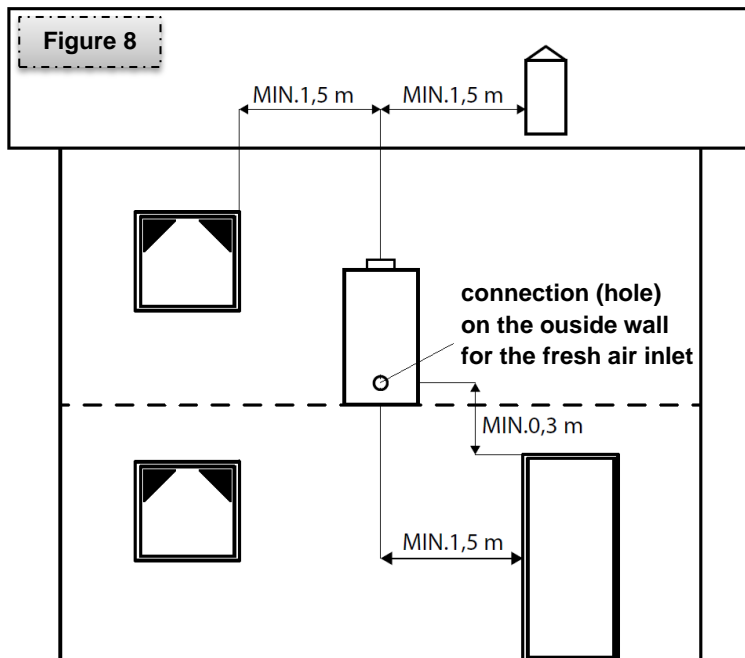

4.5. CONNECTING TO CHIMNEY

4.5.1. FLUE PIPES

When installing chimney, elements made from non-flammable materials, which are suitable and resistant to combustion products and their potential condensation, must be used. **It is forbidden to use flexible pipes which are not made from acid-resistant material** when connecting the stove with the chimney, even if the channels already exist.



Figure 9

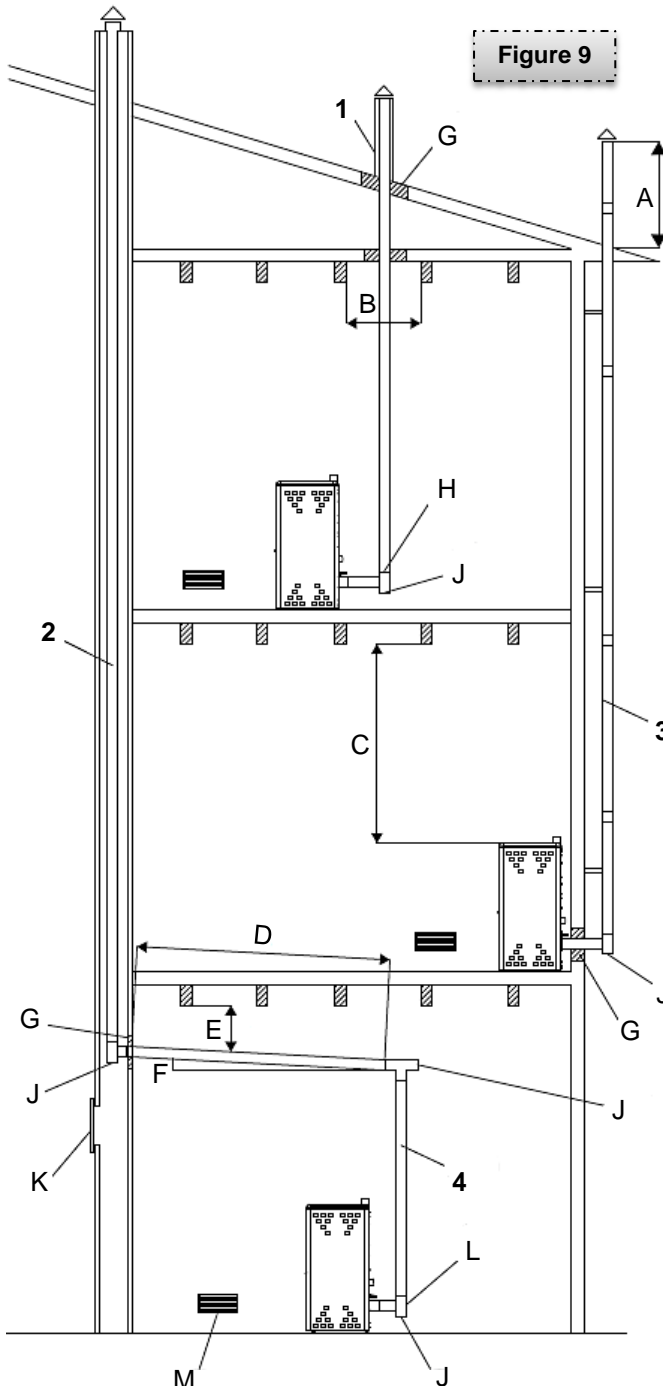

- 1 – Installation of Ø100mm diameter chimney with space around the pipe (B):
 - **min 100 mm, if the pipe is near non-flammable materials**, such as concrete, brick, and similar
 - **min 300 mm, if the pipe is near flammable materials**, such as wood and similar
 In both cases, appropriate insulation between the chimney and the ceiling is necessary
 - 2 – Existing chimney; minimum smoke venting pipe diameter Ø 80mm with external chimney inspection and cleaning hatch
 - 3 – External chimney made of insulated stainless steel pipes, Ø80mm minimum diameter. The entire construction must be safely installed onto the wall and must have a protective cap on top (see chapter 4.5.4.)
 - 4 – Smoke venting system with T-pieces enabling easier access when cleaning the chimney without the necessity of deconstructing the pipes.
-
- A – see figure 15 and chapter 4.5.4.
 - B – space around the chimney pipe
 - C – minimum 500 mm
 - D – maximum 3 m
 - E – minimum 50 mm
 - F – minimum 3°
 - G – insulation
 - H – reduction from Ø80 to Ø100 mm
 - J – maintenance and cleaning opening
 - K – maintenance and cleaning hatch
 - L – T-piece with maintenance and cleaning opening
 - M – fresh external air supply grid

Smoke venting pipes must not be conducted through rooms where installation of combustion devices is prohibited. Pipe installation must be executed in a manner **ensuring smoke impermeability** during stove operation, **limiting condensation** and disabling transfer of condensate back to the device.

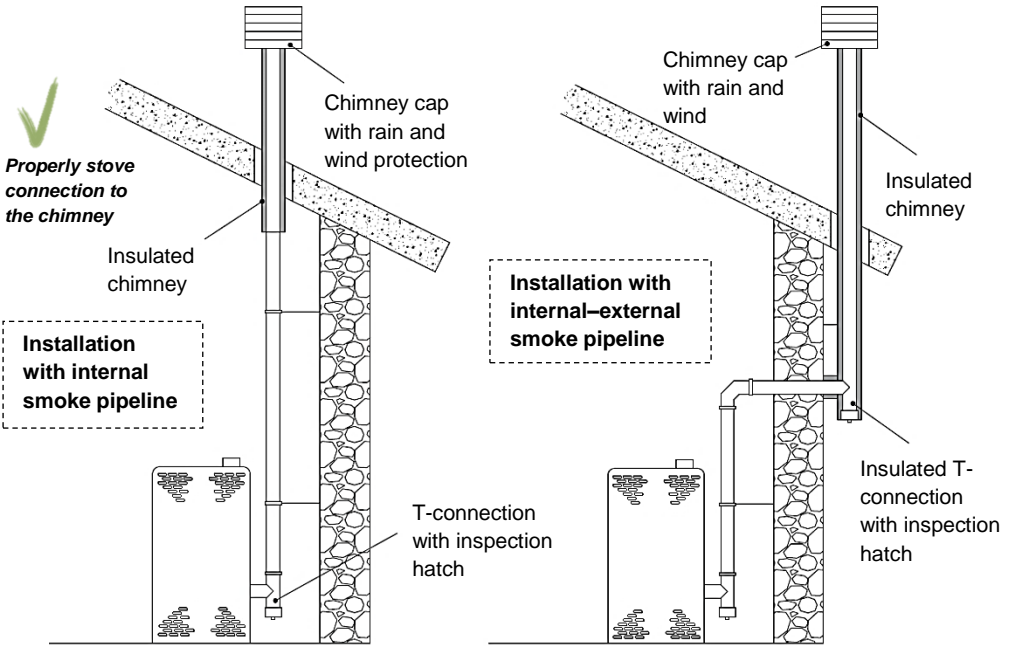
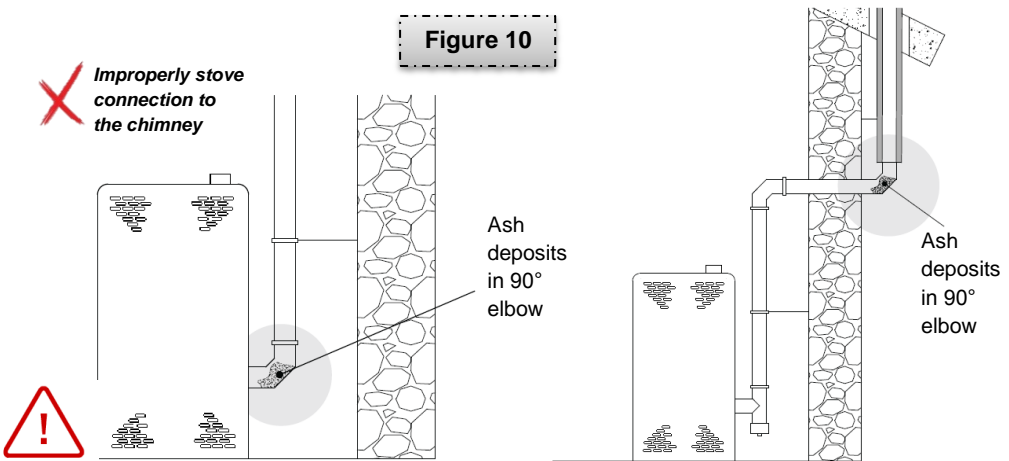

Figure 10



IT IS NOT RECOMMENDED TO USE THE 90° ELBOW AS THE FIRST ELEMENT OF THE INSTALLATION SINCE THE ASH MIGHT QUICKLY CLOG THE SMOKE VENTING SPACE AND CAUSE PROBLEMS IN STOVE AND CHIMNEY FUNCTIONING!

Installation of horizontal parts should be avoided as much as possible. When parts in question are those which must reach let-offs on the ceiling or walls unsymmetrical with the stove smoke let-off, the connection is to be executed via pipes with inclines not exceeding 45° (*figure 11*).



When installing the flue pipes, please follow the instructions below:

- horizontal parts must have a minimum 3° upward incline,
- the length of horizontal part must be kept at minimum, and should not exceed 3 m,
- number of elbows (90° angles) should not exceed 4 (including the T-piece) – should you need more than 4 elbows, use a pipe with internal diameter of Ø 120 mm),
- chimney diameters exceeding 120 mm are not suitable for direct connection to the stove, and a suitable, min. 80 mm diameter flexible smoke venting pipe (made from acid-resistant stainless material), is to be conducted through such a chimney and the chimney is to be insulated to prevent cold air from penetrating into the flue pipe!



⇒ connecting the stove to a chimney of wider diameter will result in increased thermal loss of the stove, with subsequent increase in the fuel consumption !

The stove is connected to the chimney with flue pipes with **minimum diameter** of Ø **80 mm** (pipe length up to 3 m), OR Ø **100 mm** (with pipe length exceeding 3 m). The length is obtained by adding the parts of the horizontal and vertical pipes, keeping in mind that each 90° elbow corresponds to 1 linear metre.



CAUTION! DO NOT CONNECT the flue pipe to a common flue pipe used for other heat generators (**water heaters, fireplaces, cookers and similar**) → see *figure 12*.

Figure 11

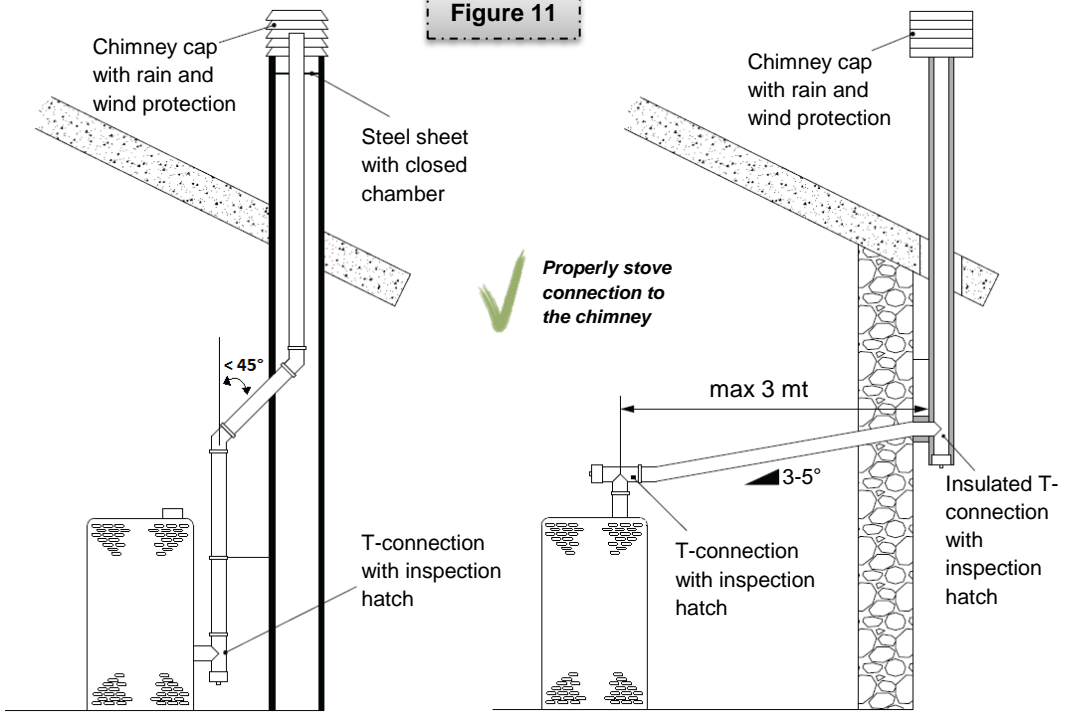
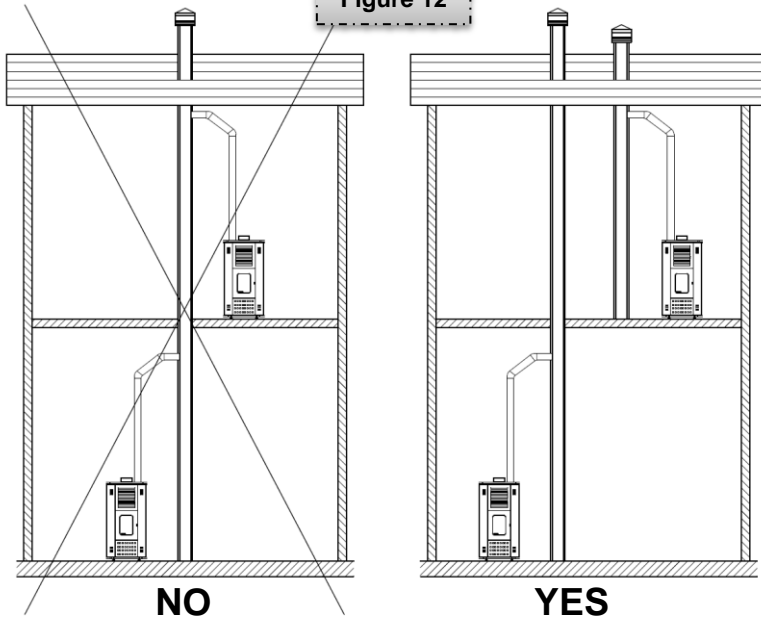

Figure 12



IMPORTANT:



- ⇒ use of elements with a different incline is prohibited !
- ⇒ smoke venting pipe must enable collection of soot and brushing !
- ⇒ smoke venting pipe must be of constant diameter !
- ⇒ potential change of the diameter is allowed only on the connection point with the chimney !
- ⇒ it is prohibited to conducted other channels or pipes through the smoke venting pipe !
- ⇒ it is not allowed to install devices for manual regulation of suction onto devices for forceful suction !

4.5.2. CHIMNEY

The chimney must meet the following requirements:



- Be **impermeable** to combustion products, **waterproof** and appropriately **insulated**;
- Be **constructed of materials that are able to withstand regular mechanical friction, heat and effects of combustion products and potential condensation**;
- Be **connected vertically** and with a decline from the axis up to 45°;
- Be appropriately **physically removed from flammable materials** by air-filled spaces or appropriately insulated;

Figure 13

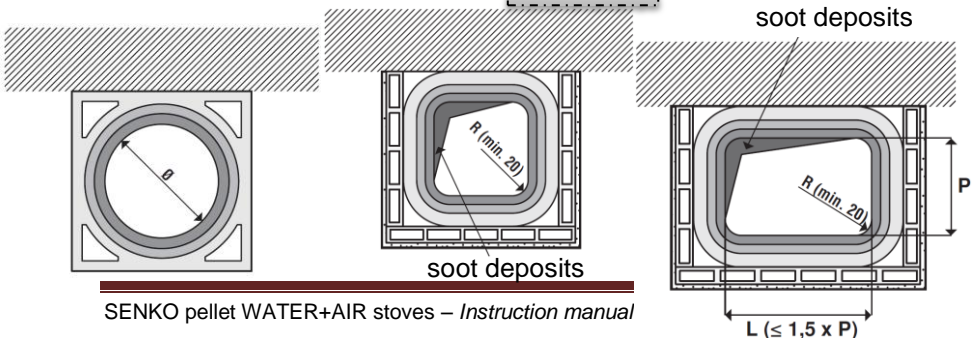

- Must have **circular internal cross-section** (cross-section can also be square or rectangular with rounded angles and a radius no less than 20 mm) → see *figure 13* ;
- Must have a **constant internal cross-section** which is free and independent;
- It can have a rectangular cross-section with a maximum ratio between the sides of 1,5 → see *figure 13*.

We advise to **equip the chimney with a chamber for collection of solid materials and potential condensation products** and to install it below the entry point into the smoke venting channel, thus allowing for easy opening and inspection via impermeable hatch.



IMPORTANT

- **BEFORE connecting to the chimney it is necessary always to make a calculation (according to EN 13384 and all other standards for the chimney dimensioning)!**
- **The chimney has a very important function of the smoke exhaust in the event of a power failure and therefore MUST BE well and properly dimensioned!**



4.5.3. CHIMNEY PREPARATION AND CONTROL

Prior to stove installation, it is necessary to inspect the chimney – diameter, height, potential clogging and damages. The chimney must be **certified by an authorized local chimney-sweeper.**



The effective **chimney height** must be **at least 5 meters** from the point of connection of chimney and the stove (*figure 14b*).

The chimney must be **at least 0,5 meters remote above the roof ridge** (see *figure 15*).

The chimney must be smooth on the inside, well insulated and well fastened. All cleaning hatches must be well fastened. All gaskets must be regularly inspected and replaced when necessary.

Figure 14

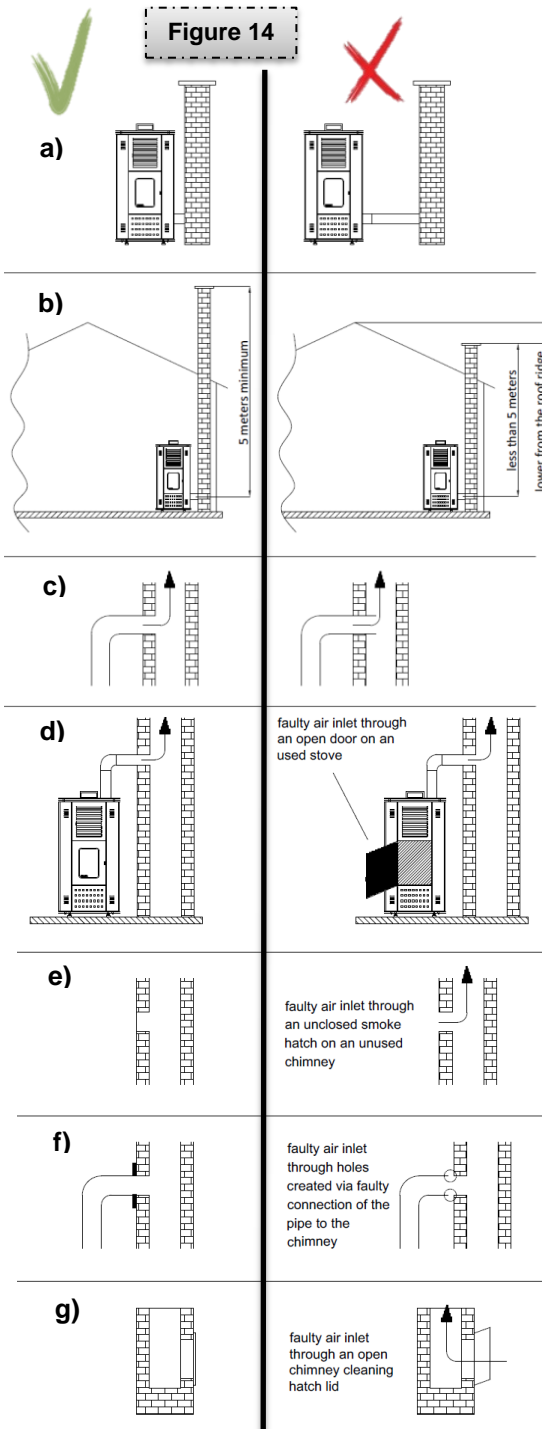

When connecting the stove to the chimney it is necessary to adhere to local, national and European regulations (norms) – DIN 4705.

It is necessary to ensure that the connection between the stove and the chimney is executed tightly and impermeably. **Smoke venting pipe must not penetrate into the chimney clear opening shaft** (figure 14c).

Differences between the proper and improper connection of stove to the chimney are displayed in figure 14.

4.5.4. CHIMNEY CAP

Chimney cap must meet the following requirements:

- **identical internal cross-section** to that of the chimney,
- **operational exit cross-section no less than the double inner cross-section of the chimney,**

- constructed **to prevent rain, snow, leaves and other foreign bodies from entering** the chimney,
- constructed **to enable expulsion of combustion products in case of wind** from any direction and incline,
- installed **to enable proper dispersion and dilution of combustion products outside the reflux zone** (backflow) because the counter pressure occurs here. Therefore, it is necessary to adhere to limitations listed in *figure 15*,
- **mechanical appliances for flue gases suction are not allowed.**



FLAT ROOF

PITCHED ROOF

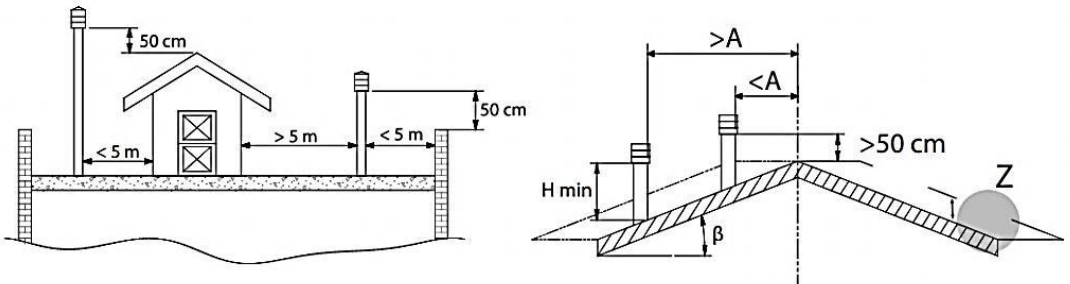

Figure 15

Z=REFLUX ZONE

Table 4

| Roof slope | Distance between the roof ridge and the chimney | Minimum chimney height (measured from the roof surface) |
|------------|---|---|
| β | A, m | H_{min}, m |
| 15° | < 1,85 | 0,5 m above the roof ridge |
| | > 1,85 | 1 m from the roof |
| 30° | < 1,5 | 0,5 m above the roof ridge |
| | > 1,5 | 1,3 m from the roof |
| 45° | < 1,3 | 0,5 m above the roof ridge |
| | > 1,3 | 2 m from the roof |
| 60° | < 1,2 | 0,5 m above the roof ridge |
| | > 1,2 | 2,6 m from the roof |

4.5.5. CHIMNEY FUNCTION

Among all the meteorological and geographical factors that influence the chimney function (rain, fog, snow, insolation period, etc.) **the wind is most certainly the crucial one**. Apart from the pressure caused by the temperature difference between the flue gases and the outer chimney air, there is another type of pressure – **wind dynamic pressure**.



Ascending wind ALWAYS has the effect of increasing the pressure, i.e., **underpressure (flue draught)**, provided the chimney is properly installed. **Descending wind ALWAYS has the effect of decreasing the draught** ⇒ overpressure occurs. Apart from wind direction and velocity, chimney position in relation to the house roof and surrounding area is also important (*figure 16*).

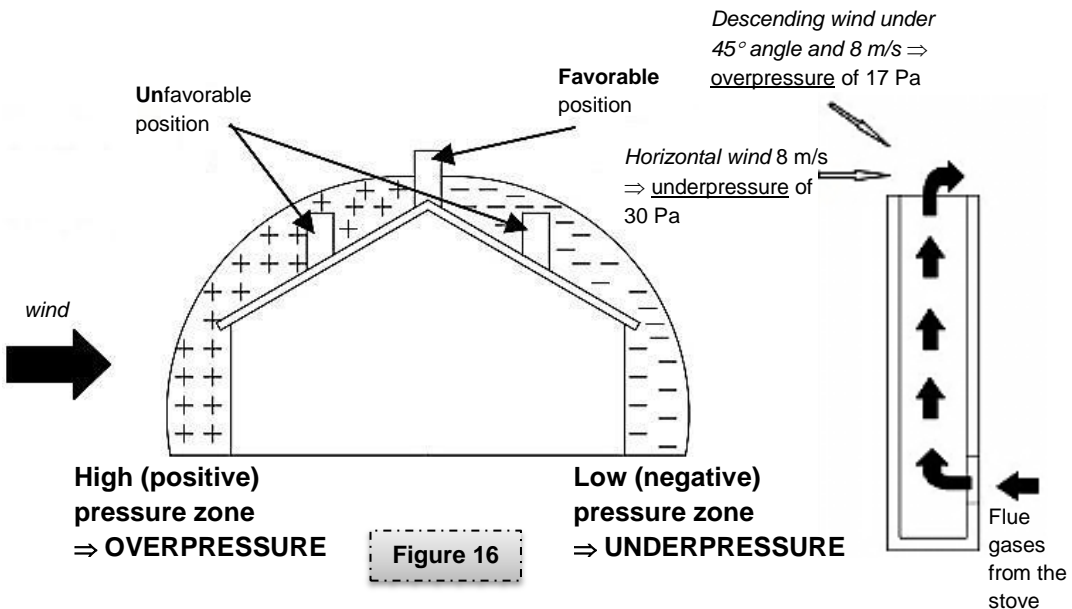

The wind also influences the chimney function indirectly by creating areas of high (overpressure) and low (underpressure) pressure, both inside and outside the residential area (*figure 17*).

Pressure that facilitates chimney function can occur in rooms directly exposed to the wind (B), but it can also adversely affect the chimney through external pressure if the chimney is situated on the side exposed to wind (A). Contrary to that, underpressure can occur in lee rooms (C), adversely affecting functions of the chimney situated on the opposite side (D) from the wind direction.

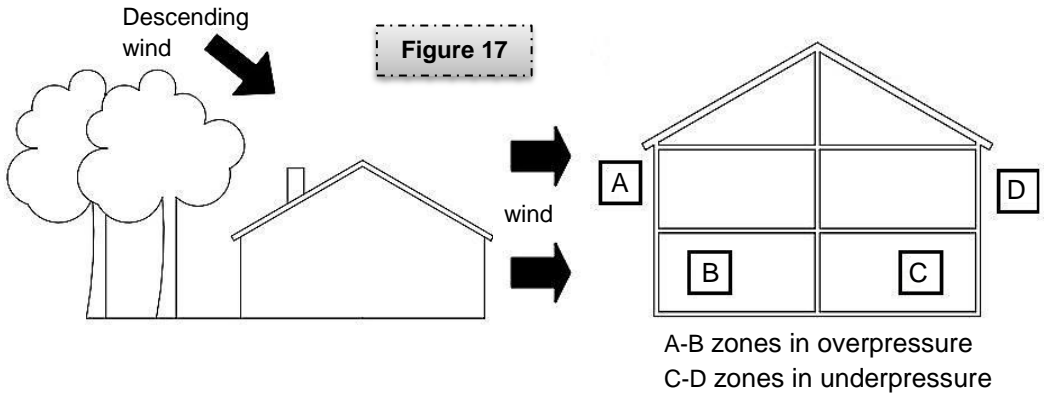

4.6. CENTRAL HEATING SYSTEM CONNECTION

Prior to commencing the firing procedure, the stove must be connected to the central heating system and the **boiler must be filled with water**.



① CONNECTIONS TO THE SYSTEM

The pipe installation **must be executed in accordance with valid technical regulations** and DIN 4751 norm – part 1 for open systems and DIN 4751 – part 2 for closed systems, following **professional standards**, and **only by an authorized expert**.



It is not allowed to reduce the pipe diameter connecting the boiler to the heating installation connection point. Otherwise, the warranty will be void.

Prior to connecting the boiler to the heating installation, **the pipelines are to be thoroughly cleansed from potential filth sediments**. This



prevents boiler overheating, system noise, pump malfunctions and mixing valve malfunctions.

IT IS STRONGLY RECOMMENDED TO WASH THE ENTIRE SYSTEM BEFORE CONNECTING IT IN ORDER TO GET RID OF POSSIBLE RESIDUES AND DEPOSITS.



The connection to the heating system is executed via union flat joint, with or without the mixing valve onto a closed or open system.



Connect the stove USING FLEXIBLE PIPES so that the stove is not too strictly connected to the system, and to allow slight movements.



The mixing valve (10 – figure 18) maintains the water temperature at **minimum 55°C**, thus preventing the boiler from condensation. If one had not been installed, it is necessary to ensure firing conditions that will prevent boiler condensation ⇒ **may appear at the beginning of the firing process or due to insufficient feeding.**



THE STOVE IS FACTORY SET TO CONNECT TO THE CLOSED CENTRAL HEATING SYSTEM (closed expansion tank)!

Regardless of the expansion tank built-in pellet stove, central heating system must also have its own expansion tank, adjusted to the expansion tank in the stove.



The stove is equipped as standard with a **safety valve 2,5 bar** (see “F” figure 1 OR “N” figure EQUIPMENT). **An outlet of the safety valve MUST be carried out into the sewer.** The water drain pipe must be adequate to support the water’s high temperature and pressure.



It is necessary to **install the vent valve** (regardless of the valve built-in stove). When filling the boiler and the radiator system it is necessary to open the mixing valve, if one had been installed; **adequately deaerate the boiler and the heating system.**



In places of any connection points on the stove (water, chimney, air inlet...), **inspection hatches must be installed for system maintenance and servicing purposes.** Also, **YOU SHOULD ADHERE TO THE SAFETY DISTANCES** (see *Figure 4*).



ORIENTEERING and SIMPLIFIED scheme of connecting to an *open* central heating system

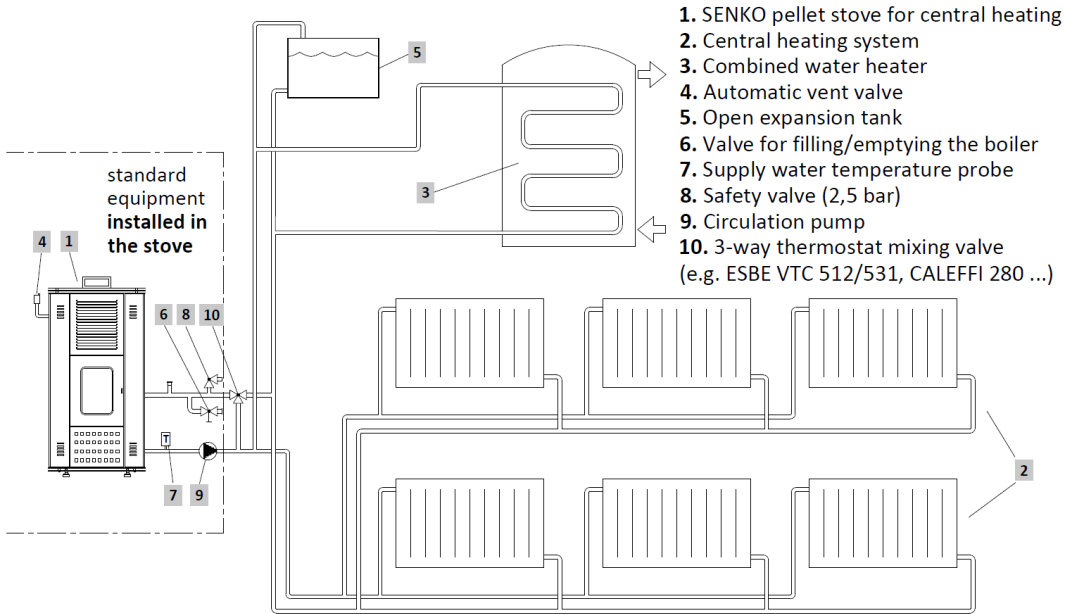

ORIENTEERING and SIMPLIFIED scheme of connecting to a *closed* central heating system

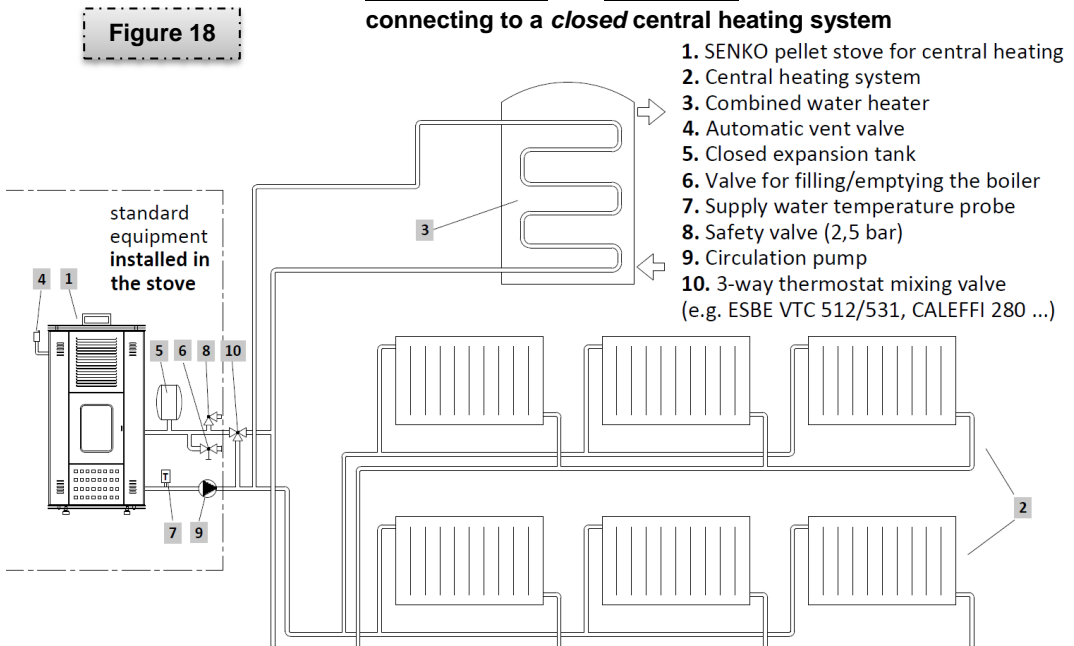

Figure 18

② SYSTEM FILLING



The boiler is filled with water via valve R1/2" on the back of the stove (see "C" figure 1 OR "O" figure EQUIPMENT). **Continuous circulation of water through the boiler** must be ensured. The boiler **must be well deaerated prior to operations commencement**. During filling, any air in the system is released from the **automatic vent valve** located at the highest point of the boiler, beneath the left side wall (see 4 figure 18).



The **filling pressure** of the boiler **WHEN COLD** must be **1 bar**.



For proper operation of the stove **WHEN HOT**, the pressure in the boiler must be **1,5 bar**.



To monitor the system pressure (and temperature), the central heating system must be fitted with thermo-manometer.

4.6.1. INSTALLATION TESTING

Prior to initial firing:

1. It is necessary to **check if the boiler and the entire heating system are filled with water and well deaerated**. Also **check if the smoke uptake pipe is properly fastened**,
2. **Activate the safety valve and check its proper functionality**,
3. **Check the pump operation** (you can do this only if the stove is in OFF).



It is necessary to turn on the pump using the following steps on the control panel: *Menu → Settings → Set → Start Pump → Set → Ok*.

If the pump doesn't work, the rotor is blocked. Switch off the power, remove the right side wall, remove the pump head (unscrewing 4 screws), clean the rotor, spin the shaft with a screwdriver, check the electrical connections of the pump and deaerate the entire system. Check again the pump operation.



After initiation make sure:

- there is no leakage of any kind,
- that the entire installation is deaerated,
- that the water temperature in the boiler is increasing,
- that boiler operations do not result in condensation in the chimney.



Repeat the entire inspection after several days of constant firing!

4.6.2. RECEIVING AND MAINTAINING THE INSTALLATION

When receiving the installation, inspect the installation in its entirety with the contractor. **The contractor is obligated to provide basic information about the installation operations and indicate the position and function of the installation key components.** Also, the contractor is obligated to complete the installation report which can be found at the end of this *Manual!*



NOTE: Before installation commissioning please read, together with the contractor, the installation and operating instructions of the pump! The pump is located behind the right side wall (see **P** on *figure 1*)!



Deaerate the entire heating system after several days and refill it with water if necessary.

Inspection of installation working performance is to be executed at least once a year by an authorized maintenance technician. This will ensure safe working performance of the boiler, as well as economic and immaculate heating.



In case of installation faulty operation, contact your central heating installation contractor exclusively!



5. HANDLING THE STOVE

5.1. PRE-IGNITION WARNINGS

During the first several times the stove is activated, we advise you to adhere to following recommendations:

- **Ventilate the room several times;**
- **There is a possibility that the stove will emit a light odour which is the consequence of used protective coatings. This smell disappears after a few hours of stove operation;**
- **This stove should NEVER be used for waste incineration.**





During the heating and cooling periods **the stove material is exposed to expansion and contraction which may result in light cracking sounds**. This occurrence is perfectly normal since the stove is constructed of steel sheets and should therefore not be considered a malfunction.



- **Do not use any flammable liquids to ignite the pellets!**

Prior to activating the stove, check the following:



- **pellet tank must be loaded with pellets,**
- **the firebox must be clean,**
- **burner pot must be clean and empty,**
- **make sure you properly install it back into the casing – Figure 39a,**
- **make sure that the firebox door are hermetically closed,**
- **make sure that the power cable is properly connected,**
- **backside switch must be set to 1.**



It is of the utmost importance **not to increase the heating power to maximum already in the beginning**; increase the power gradually instead. In manual mode use lower heating levels (e.g. *fire 1-2-3*). After several minutes you can use the remaining available heating levels (*fire 4-5*), BUT keep in mind that the **stove may operate on maximum (nominal) power up to 3 h**. In this manner, damages that may occur on construction materials are avoided.



After longer periods of inactivity, all pellet residues must be vacuumed from the tank due to the fact that they can absorb water which alters their original properties, making them unsuitable for combustion and transport to the firebox.



It is MANDATORY that before first ignition you make the calibration or pellet feeder correction according to Chapter 5.9.2. and Table 12.



In case of power failure, and when power returns, the flue gas fan will work with its maximum speed to extract the remaining smoke from the firebox. The display will show "SHUT DOWN". After this process is complete and the stove reaches the state OFF, you must manually turn on the stove by pressing the ON/OFF key (for the duration of 2 sec).

5.2. LOADING THE PELLETS

Open the lid (pellet tank handle you got with your stove) on top of the stove. Pour pellets into the tank. Maximum tank capacity depends on the stove type.

- Do not try to remove the protective grid from the tank!
- While loading the pellets, the scoop (or bag) must not come into contact with the hot stove!
- Do not pour any other fuel other than pellets compliant with norms mentioned in *chapter 2* into the tank!

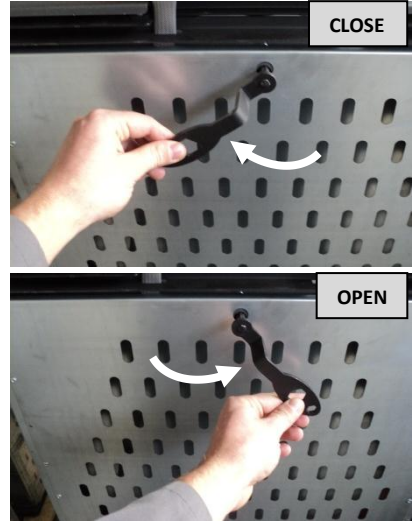

Figure 19

5.3. CONTROL PANEL

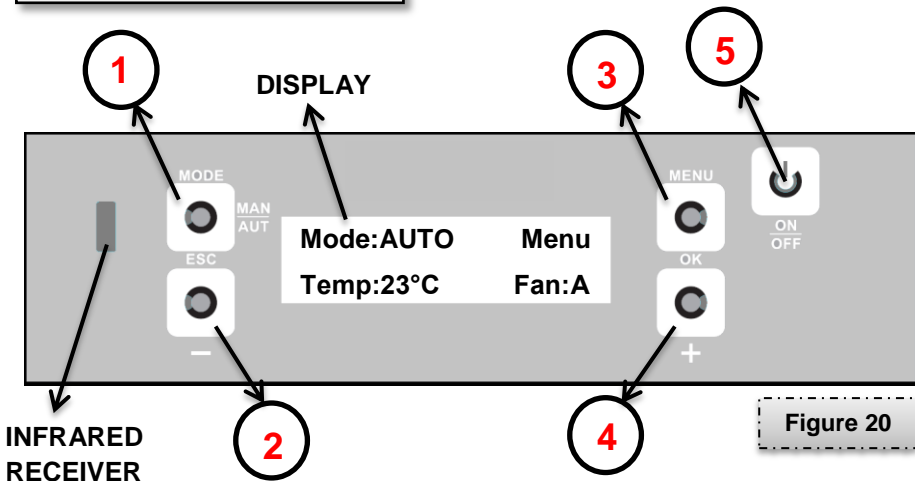

Figure 20

- KEY:**
- 1 – parameter selection and alteration (**MODE, ESC, MANU / AUTO**)
 - 2 – parameter selection and alteration (-)
 - 3 – parameter selection and alteration (**MENU, Set, OK**)
 - 4 – parameter selection and alteration (+)
 - 5 – **ON/OFF** (turning on / turning off)



NOTE: All explanations hereinafter will refer to the buttons on this *Figure 20*.

Useful information for understanding the functioning of the control panel:



- Backlight of the control panel screen turns off after approximately 30 seconds unless any key is pressed. To turn on the backlight again, press any key on the control panel.
- The display always shows the stove operating status (ON, OFF, IGNITION, SHUT DOWN...) which indicates the currently activated settings (CHRONO, SLEEP, AUTO, ECO...).
- By pressing any of the 4 keys around the screen (1 2 3 4) you are accessing the menu in which you can alter the operational parameters of the stove (heating power – FIRE, ventilator speed – FAN, room heating temperature – TEMPERATURE, manual or automatic mode – MANU / AUTO, etc.). Each of these 4 keys has its assigned function, i.e. they directly refer to words displayed on the screen in the immediate vicinity of each of these keys (e.g. the word in the lower left corner refers to key 2).



- **When changing the heating power it is important to note that the ascending power changes with a delay of 1 minute, while the descending power changes with a delay of 4 minutes.**
- Should you, during alteration of a parameter in any menu, fail to confirm the change by pressing key 3 (Ok), and leave the key inactive for 10 seconds, START display appears and the change is NOT saved.
- Should you, in any menu, shortly press key 5 (On/Off), START display will automatically appear on your screen (display of stove operating status) without saving any changes not confirmed by „Ok“ key 3.

5.4. REMOTE CONTROL

The remote control allows you to regulate the heating power, speed of warm air ventilator and stove activation and deactivation. When used, the remote control must ALWAYS be directed toward the infrared receiver on the control panel (figure 20).

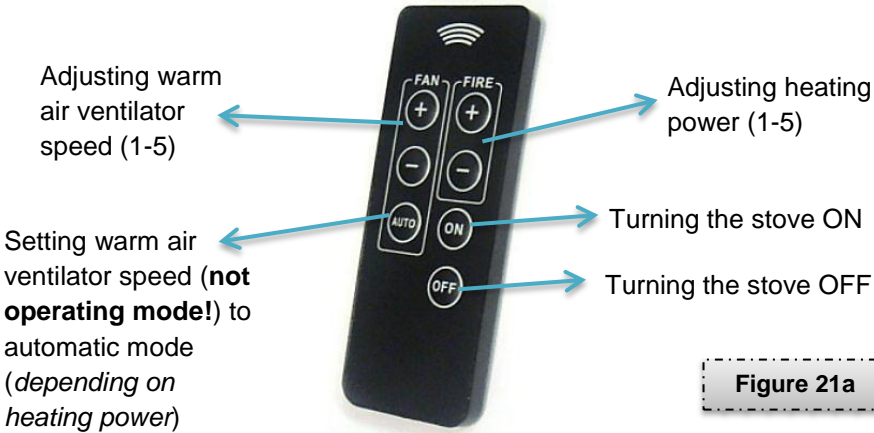

Figure 21a

- **Keep the remote control away from direct sources of heat and water!**
- **Keep the remote control away from children!**
- It may happen that the remote control of another device (TV, radio ...) is on the same frequency as the remote control of your stove. In this case, the function of the stove remote control must be switched off!



Prior to remote control initial use, the protective foil must be removed from the back side (see figure 21b). If you wish to replace empty battery, it is necessary to pull out the battery holder (as shown in figure 22) on the back side of the remote control and change the battery in accordance with the symbols displayed on it. **3V Lithium CR2025** battery is used in the remote control.



Figure 21b

Figure 22

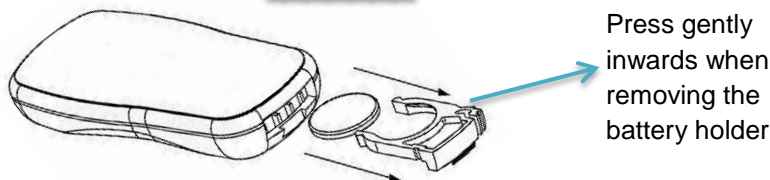

When replacing the battery, make sure you have properly placed the battery in accordance with the polarity (+/-) indicated on the inside of the remote control!

If the remote is not functioning or you are presently unable to replace the battery, you can operate the device from the control panel.



Do not dispose of the empty batteries into the environment; use the special container!

5.5. BEFORE FIRST SWITCHING ON

Plug one end of the power supply cable into the socket (**the socket must be grounded!**) and connect the other end to the switch on the backside of the stove. After connecting the power supply cable onto the backside of the stove, **set the switch to position (I)**. As soon as the switch turns on the power supply, the control panel should produce an audio signal.

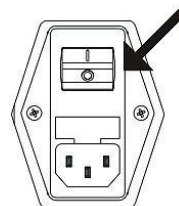

Once the control panel has been turned on, manufacturer logo appears on the screen in the second line of the display, while the first line indicates current room temperature and time (*figure 23*). Every 4 seconds the initial screen switches with another screen which, in the bottom line, indicates the type of stove currently stored in the main memory (P12WATER or P20WATER). During switching between these two displays, the backlight is maximally maintained and pressing any key will have no effect.

After approximately 12 seconds, „START“ screen appears (figure 24) ⇒ this indicates that the system is ready.

The first line of the display LEFT indicates the current room and water temperature (0,5°C precision) and RIGHT is current time. The bottom line of the display switches every 2 seconds between options that describe the current stove status with active functions (table 5) and active alarm, if there is one.

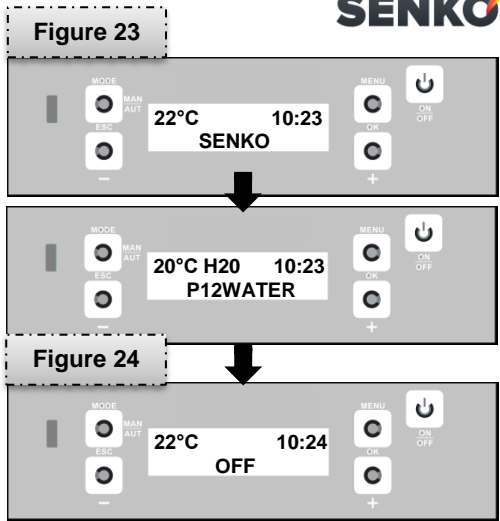

Table 5

| Function | Displayed options |
|-------------------------|--------------------------|
| Current stove status | IGNITION |
| | ON |
| | SHUT DOWN |
| | OFF |
| | SHUT DOWN AFTER BLACKOUT |
| | IGNITION AFTER BLACKOUT |
| Chrono mode active | Chrono Prog. |
| Sleep mode active | Sleep 12:30 AM |
| Modem active | Modem is Active |
| „Eco“ active | Eco is active* |
| Alarm conditions active | Warnings** |

* this notification is displayed only if the ECO option is enabled (ON)

** this notification is displayed only if at least one alarm is active

For all the displays described below, screen backlight will be maximally maintained; unless a key is pressed within 10 seconds, the display returns to START screen (*figure 24*), and screen backlight is reduced (after 30 seconds); after additional 20 seconds, the backlight is deactivated.

Once the screen backlight is deactivated, it can be reactivated by pressing any key, after which a display with a selection **MENU** will appear (*figure 25*).

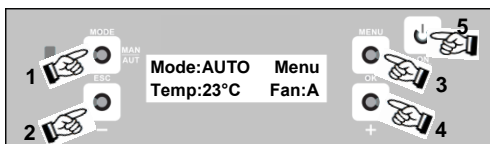

Figure 25

As shown in the previous figure, descriptions of functions appear on the screen:



1. Operating mode selection key (**Mode**) – changes the operating mode from manual to automatic (MANU / AUTO) ;
2. Temperature change (5-35°C) / heating power (1-5) key (**Temp / Fire**) depending on the previously selected operating mode;
 → Press and hold the key for 2 seconds!
3. Pressing the menu key (**Menu**) enables the choice of additional functions (see *chapter 5.8.*);
4. Warm air fan speed adjustment key (**Fan**) – 5 speed levels;
5. Turning on / turning off key (**ON/OFF**) returns the display to START screen.

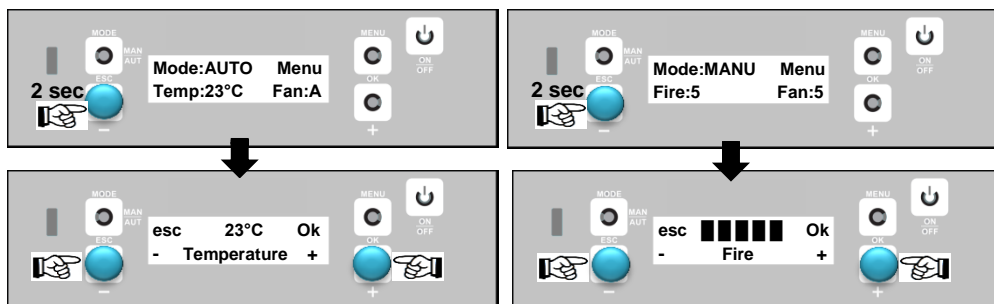

Figure 26

5.5.1. DATE AND TIME MENU

By pressing key 3 (Menu), Menu < **Day and Time** > will appear.
Available functions are listed in the following table and figure.

Table 6

| Function | Value |
|------------|-------------|
| Time | 00 - 23 |
| Minutes | 00 - 59 |
| Day | Mo – Su |
| Day Number | 00 - 31 |
| Month | 01 - 12 |
| Year | 2010 - 2109 |

In this menu, the parameter you wish to alter (key 3 – **Set**) begins to flash on the screen. By pressing keys 2 and 4 you decrease or increase the parameter in question. Any change you have made must be confirmed by pressing key 3 (**Ok**), **otherwise the change will not be saved**. By pressing key 1 (**Esc**) you can **return to the previous menu but without saving the changes**.

Should you not press any key within 10 seconds, the display returns to **START** screen without saving the changes!



Figure 27

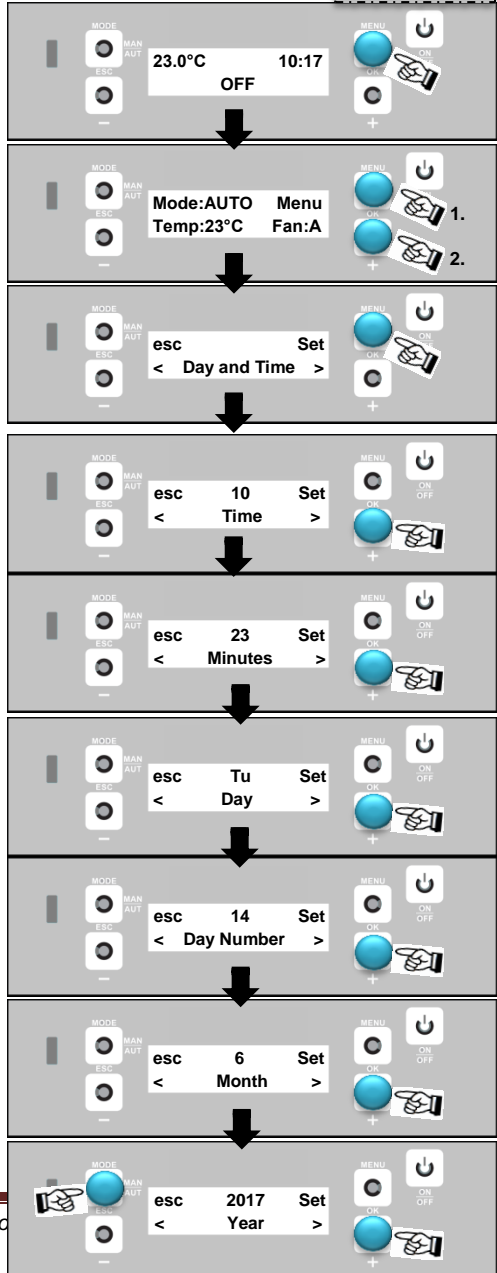

5.5.2. WATER TEMPERATURE MENU

By pressing key 3 (Menu), Menu < **Water Temp.** > will appear. Available functions are listed in the following table and figure.

Table 7

| Function | Value |
|------------------|-----------|
| Heating Temp.* | 40 – 85°C |
| Sanitary Temp.** | 35 – 60°C |

* default 65°C

** **this function is not used**

In this menu, the parameter you wish to alter (key 3 – **Set**) begins to flash on the screen. By pressing keys 2 and 4 you decrease or increase the parameter in question. Any change you have made must be confirmed by pressing key 3 (**Ok**), otherwise the change will not be saved. By pressing key 1 (**Esc**) you can return to the previous menu but without saving the changes.

Should you not press any key within 10 seconds, the display returns to **START** screen without saving the changes!



Figure 28

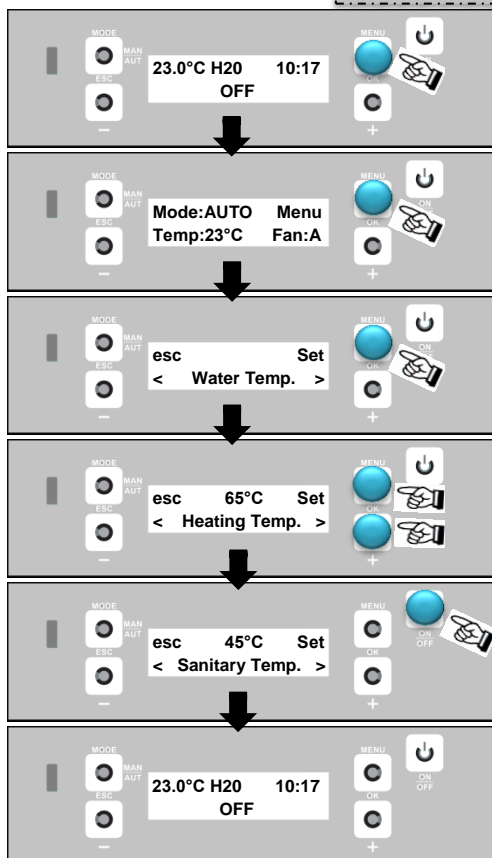

5.6. IGNITION / SHUT DOWN

The stove is **turned ON** by pressing the **ON/OFF** key on the control panel **for the duration of 2 seconds** (key 5 – figure 20) or by pressing **key 1 (ON)** on the remote control. The control panel will produce an audio signal and the screen will display the **IGNITION** option.

After initial ignition which may last up to 20 minutes maximum (# - see next page) (every subsequent ignition lasts 5 - 10 minutes), the stove gradually achieves normal operation status.

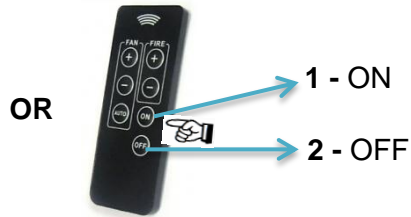
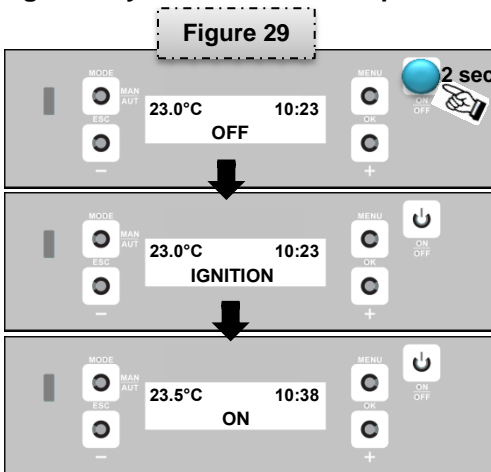

The first attempt to activate the stove may not be successful since the pellet feeder (spiral) is completely empty at the beginning and



does not distribute the same quantity of pellets into the firebox every time. In that case, the control panel produces an audio signal and **alarm A01** appears on the screen (see Table 15 and Figure 38)!



Cancel (reset) the alarm on the control panel (hold the **ON / OFF** button for longer than 2 seconds), **wait until the stove has cooled to the state OFF**, **clean the burner pot** and **repeat stove ignition sequence** !



If, after reactivation (around 20 minutes), the pellets are not yet ignited, check whether the burner pot is properly set. **The burner pot must completely adhere to its casing and must not contain any ash.**



If the alarm A01 recurs, see **Informations** in **Table 15**.

Should ignition malfunctions appear even after this check, there is a problem in certain stove components OR the stove is not properly installed



→ **clean the firebox and contact the authorized maintenance technician!**



you can avoid problems with initial ignition by activating pellet dosage function prior to the activation of the stove

this function can be found in SETTINGS menu under **< Charge Pellet >**



after activating pellet dosage, it is necessary to wait for several minutes until the pellet feeder spiral is filled and first pellets are distributed into the burner pot

after that turn of dosage by pressing key 1 (**esc**) and return to START screen

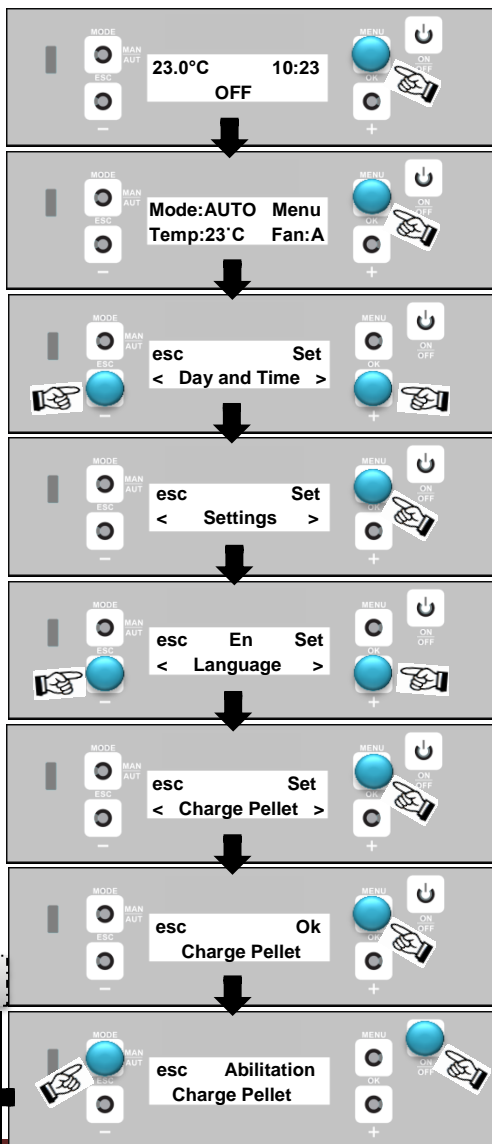
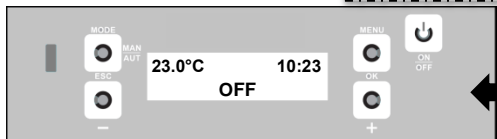
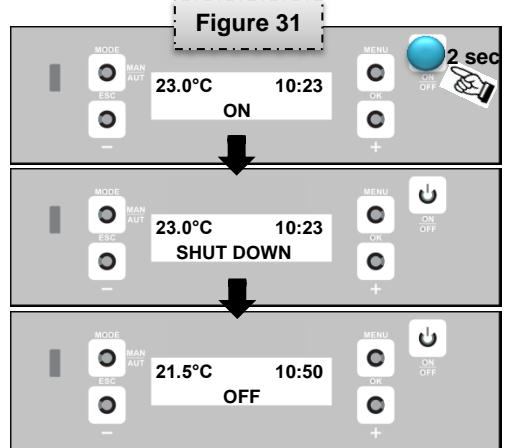

Figure 30



The stove is **turned OFF** by pressing **key 5** (on the control panel) for **2 seconds** or by pressing **key 2** (on the remote control). After pressing one of these two keys, **the cooling stage is initiated**. At this stage, pellet distribution to the firebox is stopped and cleaning of the firebox (ash is blown out → fan operates at maximum speed) and continual stove cooling are initiated. The cooling stage **may last 20 to 60 minutes**^⓪, depending on how long the stove has been operating on maximum power and its location. After the cooling stage, **OFF** appears on the display (stove turned off).



^⓪If you want to reduce the shutdown duration of the stove which was working on power 1 (*Fire: 1*) until shutdown, **before switching off** the stove you must **set the heating power to 5** (OR warm air fan set to *Fan: 5*), and for approximately 5 minutes switch off the stove.

- **NEVER unplug the power supply cable from the socket to turn off the stove!**
- **NEVER set the switch to position “0” to turn off the stove!**
- Please wait while automatically shutting down and stove cooling is finished.

5.7. OPERATING MODE

5.7.1. MANUAL MODE (MANU)

In this mode you can adjust heating power (*Fire: 1 – 5*) and warm air ventilator speed (*Fan: 1 – 5*). By pressing any key on the control panel, selection screen will appear on the display (figure 32). If the system is in automatic mode, pressing the upper left key (**Mode**) will change the mode into manual (**MANU**).

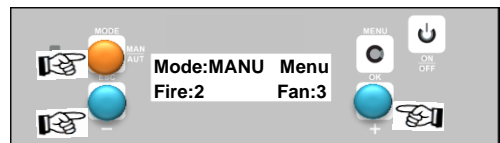

Figure 32

5.7.2. AUTOMATIC MODE (AUTO)

Unlike the manual mode where you can adjust the heating power, in automatic mode you **can adjust the room temperature (Temp: 5 – 35°C)**. The room temperature is measured by a probe (P-figure 33a) – black wire, situated on the stove backside, next to the activation switch. In order to more realistic room temperature measuring, it is necessary to **ensure that the probe is located away from any heat influence**.

You can connect the stove also to the **room thermostat**. Thermostat wires must be attached to the **JC connection** on the back of the stove. In this case the probe (P) at the back of the stove will no longer have its function. The authorized individual must activate the thermostat in the technical menu.

Please note that, in AUTO mode or if the room thermostat is enabled, **the electronics will reduce the stove heating power at a temperature (room or water) which was first reached**.

The stove will automatically change the heating power to keep the set temperature constant. **Warm air ventilator speed changes automatically (Fan:A) to accommodate current heating power**.

By pressing any key on the control panel, selection screen will appear on the display (figure 33b). If the system is in manual mode, pressing the upper left key (**Mode**) will change the mode into automatic (**AUTO**).

The stove will operate on maximum power until the set temperature is achieved. **Once the set temperature is achieved,**

the stove will gradually reduce the heating power (with a delay of 4 minutes between 2 powers) to minimum. When the temperature drops below the set value, the stove gradually returns to maximum heating power (with a delay of 1 minute between 2 powers) to reach the set temp.

After each ignition, the stove returns to the operating mode selected before the last shut down!

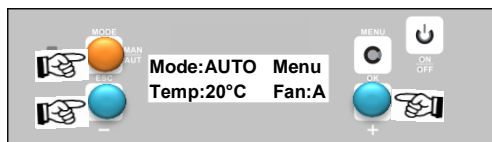
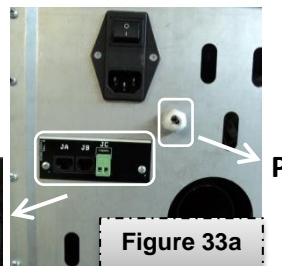

Figure 33b

5.7.3. ECO MODE (ECO)

This mode is similar to automatic mode. Unlike the automatic mode, which reduces the heating power to minimum once the set temperature is achieved, **ECO mode TURNS OFF the stove once the set room temperature is achieved.** When the set room temperature drops for a value which is factory set to **3°C** and after a predetermined stove cooling (shut down) period has elapsed, **THE STOVE IS AUTOMATICALLY RESTARTED.**

E.g.: If the current room temperature is 18°C, and you have set the temp. on the control panel to *Temp:23°C*, the stove will operate on max. heating power (*Fire 5*). Once the set temp. is reached (23°C + 1 = 24°C), the stove goes to min. power (*Fire 1*). Now (from detection of 24°C) the electronics start to countdown the time (factory set) of **20 min**. If during this time (20 min) the temperature is still more than 23°C, the stove automatically shuts down (*SHUT DOWN*).

When the stove begin with shut down, the electronics start to countdown the time (factory set) of **40 min**. At the end of this time (40 min) the electronics control the room temperature. If the room temperature is constantly more than 23°C (**set**) **MINUS 3°C** (factory set) → so if temperature is more than 20°C, the stove doesn't start again. **The stove will start (IGNITION → ON) again only when: 40 min has passed AND the room temperature is LESS than 20°C** (e.g. 19°C).

Figure 34

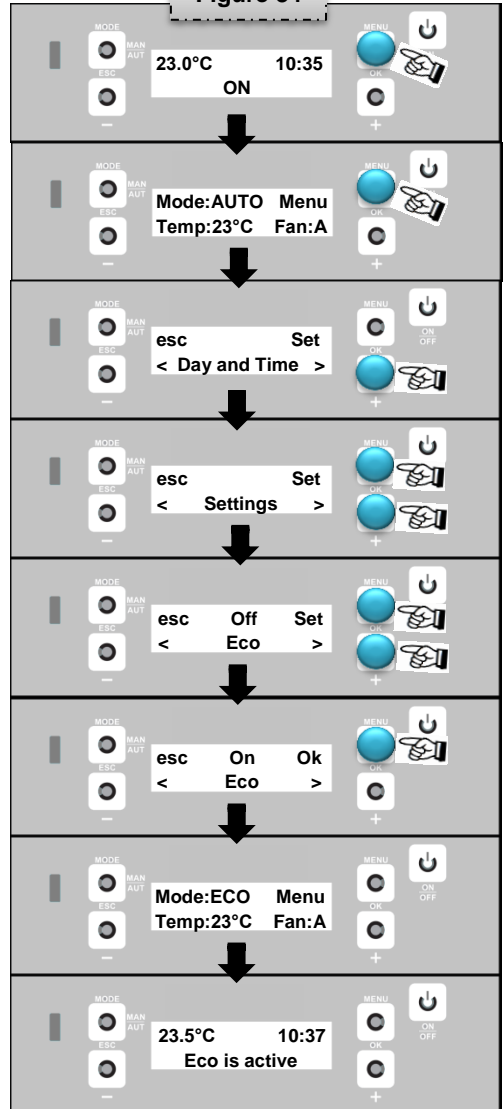



Press the upper right key on the START screen, and a selection screen will appear (*figure 34*). By pressing the same key (**Menu**) and moving the display (by using the lower right key) you will reach the **Settings** display. Press the upper right key (**Set**) again and move the screen until you reach **Eco**. Press Set again and select **On** and confirm with **Ok**. **ECO is active** appears on the display. To turn off Eco mode follow the same procedure.



- **ECO mode remains active until it is set off from the Settings menu!**
- **This operating mode is recommended only for stoves installed in well-insulated rooms with insignificant heat losses!**
- **Please note that after several re-ignitions and because of unburned pellets (ash) in the burner pot, could result in bad ignition of new inserted pellets → possible release of smoke into the room!** Therefore please clean the burner pot if necessary.
- **In manual mode (MANU), it is possible to enable ECO only if the room thermostat is active**

5.7.4. WARM AIR FAN (FAN)

As previously mentioned, the stove is equipped with a warm air fan, which **heats the space through grid on the stove front side**. You can set **5 different blowing speeds** depending on the operating mode the stove is in (AUTO or MANU).



In AUTO mode, the fan speed is related to the stove heating power. E.g. if the heating power is 3 (*Fire: 3*), the fan is automatically set to speed 3; if the heating power is 5 (*Fire: 5*), the fan speed is 5, etc. The control panel displays **Fan:A**.

The speed adjustment is simply achieved 1-2-3-4-5 by pressing the lower right key on the control panel.

| | | | |
|-------------|---------|------------|---|
| MANU | Fire: 1 | Fan: 1 - 5 | ✓ |
| | Fire: 2 | Fan: 2 - 5 | |
| | Fire: 3 | Fan: 3 - 5 | |
| | Fire: 4 | Fan: 4 - 5 | |
| | Fire: 5 | Fan: 5 | |
| AUTO | Temp: | Fan: A | ✗ |
| | Temp: | Fan: 1 - 5 | |
| | Temp: | Fan: 1 - 5 | |
| | Temp: | Fan: 1 - 5 | |
| | Temp: | Fan: 1 - 5 | |



- **it is not recommended to set fan speed smaller than the set heating power !**
- **otherwise, it comes to stove overheating and alarms A04 or A03 occurs. The ultimate consequence is damage on the electronics and the stove !**

5.8. ADVANCED FUNCTIONS

5.8.1. AUTOMATIC SHUT DOWN (SLEEP)

This function is used to **set (programme) the time when you want the stove to turn off**. The function **Sleep** is displayed on the control panel only if the stove is activated or in the ignition process.

Available values can be set beginning with the first ten minute interval after the current time (e.g. if the current time is 15:43, the first value you can set is 15:50), and the maximum is 23 h and 50 min after the current time.

This function is set similarly to the previously described stove Eco operating mode. Once this function is set, it appears on the START screen, e.g. **Sleep 15:50**.

Figure 35

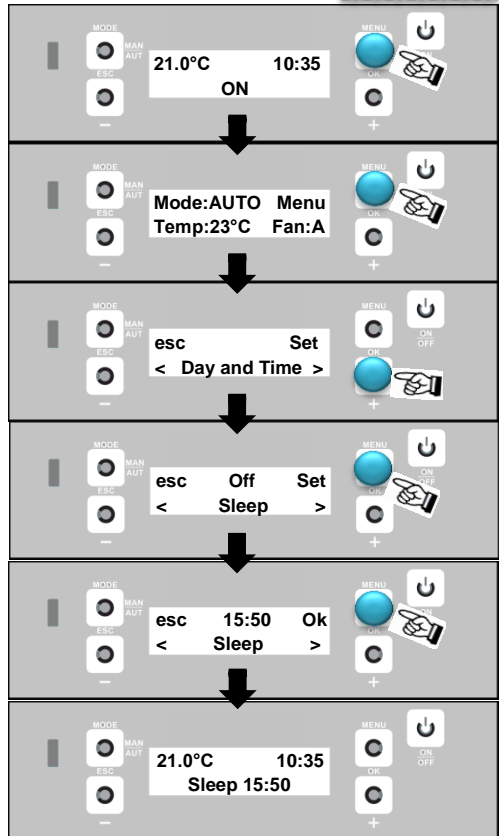

5.8.2. TIMER (CHRONO)

This function allows you to set **6 different on/off daily schedules**. Each schedule can be assigned to one or more days of the week, which ensures a **very flexible and easily adjustable weekly schedule** which suits all your needs.

Available Chrono functions are listed in *table 8*, in the same order as they appear on the display.

Table 8

| Function | Description |
|-----------------|---|
| Enable | On/Off |
| Load Profile | Loading pre-set defined templates of weekly profiles; P01 – P10 (see chapter 5.8.2.1.) |
| Reset Chrono | Cancelling all current settings; confirmation is needed (key „Ok“) to return to default values |
| | Prog. 1,2,3,4,5,6 |

Setting the **6 available programmes** is executed in a new menu, with the list of parameters as described in the following table.

Table 9

| Function | Value |
|-----------------|----------------------------|
| Enable | On/Off |
| Start | 0-23 (15 minute steps) |
| Stop | 0-24 (15 minute steps) |
| Air Temp. | 5-35°C (18°C by default) |
| Water Temp. | 40-85°C (60°C by default) |
| Fire | 1-5 (1 by default) |
| Days | Mo, Tu, We, Th, Fr, Sa, Su |

In order to activate each daily schedule, start and stop hours need to be set, in order to define the time interval.



- **CHRONO** function can be programmed (activated) or deactivated whether the stove is in OFF-state or in ON-state!
- If you have activated any of the Programmes, *Chrono prog.* will appear on the control panel **START** screen!

Recommendations:

- activation and deactivation time intervals should include one day only, from 00:00 to 24:00h, which means that the stove can't work from Friday to Saturday, for instance !

- EXAMPLE: ⇒ start at 06:00 h
 ⇒ stop at 17:00 h ✓
 ⇒ start at 21:00 h
 ⇒ stop at 05:00 h ✗



✗ WRONG

➔ SOLUTION:

Prog1: Start 21:00, Stop 00:00

Prog2: Start 00:00, Stop 05:00

⇒ the programme will use the lower value (05:00 h) as activation !

- according to previous example, you can programme only „ascending“ hours, but NOT „descending“!
- before using the Chrono function, you should set the current day and hour (if you still haven't) following instructions in *chapter 5.5.1. !*
- for the Chrono function to work, it needs not only be programmed, but also activated (ENABLE) as shown in figure 36.

Figure 36

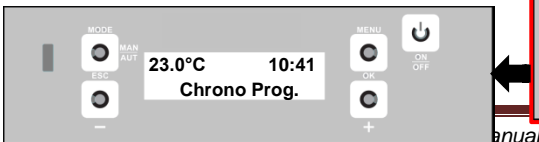
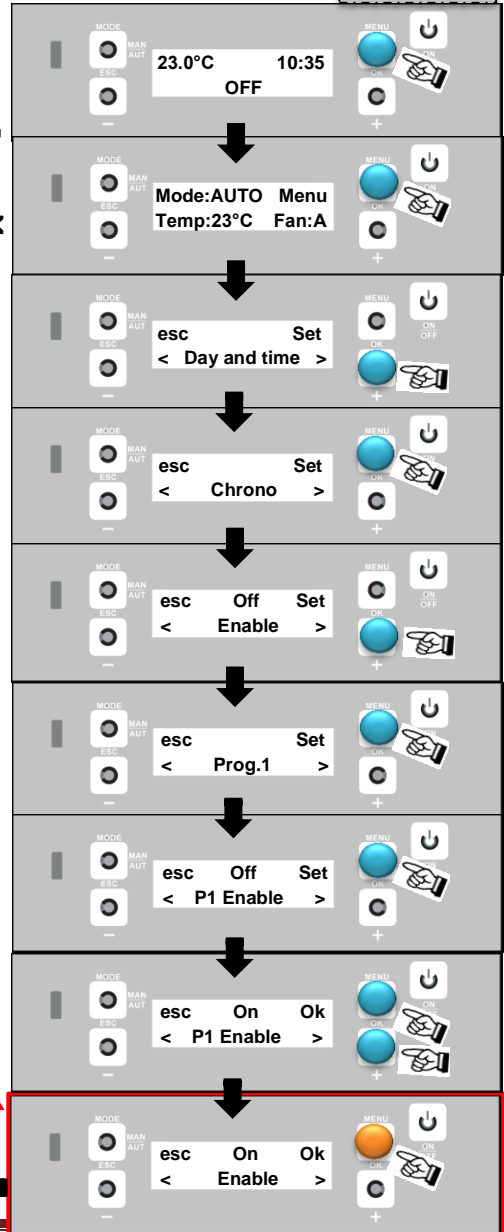

5.8.2.1. WEEKLY PROFILES



A group of 10 weekly profiles (programmes) for quick setting of on/off stove use times is available on the control panel. Each profile is defined with start/stop times per particular days. **Once you have selected a particular profile, you can freely change all the parameters that define it.** You can see the selection procedure in *figure 37*, and the list of available pre-set default profiles in *table 10*.

Figure 37

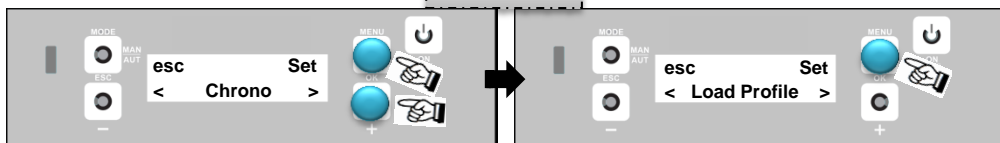

ON OFF

Table 10

| P. | Days | Scheduling | | | | | | | | | | | | | | | | | | | | | | | |
|----|-------|------------|----|----|----|----|----|----|----|----|----|----|----|----|----|----|----|----|----|----|----|----|----|----|----|
| | | 00 | 01 | 02 | 03 | 04 | 05 | 06 | 07 | 08 | 09 | 10 | 11 | 12 | 13 | 14 | 15 | 16 | 17 | 18 | 19 | 20 | 21 | 22 | 23 |
| 1 | Mo-Fr | | | | | | | | | | | | | | | | | | | | | | | | |
| | Sa-Su | | | | | | | | | | | | | | | | | | | | | | | | |
| 2 | Mo-Fr | | | | | | | | | | | | | | | | | | | | | | | | |
| | Sa-Su | | | | | | | | | | | | | | | | | | | | | | | | |
| 3 | Mo-Fr | | | | | | | | | | | | | | | | | | | | | | | | |
| | Sa-Su | | | | | | | | | | | | | | | | | | | | | | | | |
| 4 | Mo-Fr | | | | | | | | | | | | | | | | | | | | | | | | |
| | Sa-Su | | | | | | | | | | | | | | | | | | | | | | | | |
| 5 | Mo-Sa | | | | | | | | | | | | | | | | | | | | | | | | |
| | Su | | | | | | | | | | | | | | | | | | | | | | | | |
| 6 | Mo-Fr | | | | | | | | | | | | | | | | | | | | | | | | |
| | Sa-Su | | | | | | | | | | | | | | | | | | | | | | | | |
| 7 | Mo-Fr | | | | | | | | | | | | | | | | | | | | | | | | |
| | Sa-Su | | | | | | | | | | | | | | | | | | | | | | | | |
| 8 | Mo-Fr | | | | | | | | | | | | | | | | | | | | | | | | |
| | Sa-Su | | | | | | | | | | | | | | | | | | | | | | | | |
| 9 | Mo-Fr | | | | | | | | | | | | | | | | | | | | | | | | |
| | Sa-Su | | | | | | | | | | | | | | | | | | | | | | | | |
| 10 | Fr | | | | | | | | | | | | | | | | | | | | | | | | |
| | Sa-Su | | | | | | | | | | | | | | | | | | | | | | | | |

- i** If some Chrono programme is active, and you want to pre-turn on / off the stove, change AUTO/MANU mode, the command (change) that you created has the advantage ahead of Chrono. *Example:* the Chrono is set to turn on at 8:00, but you choose to turn on the stove at 7:00. The stove will be normally turned on at 7:00, and ignition at 8:00 will be ignored. In any case, the Chrono programme will remain unchanged (turn on at 8:00).
- i** If you want to change some parameter such as heating power (*Fire*) or temperature (*Temp*), Chrono will accept the change you have made BUT after 15 minutes the stove will continue to operate according to the Chrono programme. *Example:* the stove is working on *Fire:1* (Chrono), but you choose to change the heating power to *Fire:3*, after 15 minutes the stove will return to *Fire:1*.



5.9. SETTINGS

The settings menu, just like the main menu, includes a list of information and parameters, and it is used just like the main menu. The following table lists various options in the order they appear on the screen, together with their values.

Table 11

| Option | Value |
|---------------|------------------------------|
| Language | Hr-Fr-Es-De-Nl-It-En |
| Eco | On/Off |
| Back light | On - 1200 sec (10 sec steps) |
| Tones | On/Off |
| °C/°F | Auto / °C / °F |
| Pellet Recipe | <i>see chapter 5.9.2.</i> |
| Charge Pellet | <i>see chapter 5.9.3.</i> |
| Cleaning | <i>see chapter 5.9.4.</i> |
| Pump start | Enable – Ok/Esc |

5.9.1. BACKLIGHTING

Backlight option **enables you to set the time and the used level of backlight on the START screen.** If you choose ON, the screen will be lighted all the time; other data set the time interval in which the backlight is reduced.

5.9.2. PELLETT FEEDER CORRECTION (*PELLET RECIPE*)



This option allows you to alter two pieces of data to alter the main cycle of pellet feeder. **Regulate the percentage of pellet dosage.**



Depending on pellet type (quality) your stove will distribute more or less pellets. To determine how larger/smaller your dosage is from default factory settings, we advise you to apply the following procedure (**BEFORE FIRST IGNITION**):

- **Be sure that the pellet feeder spiral is full of pellets** (see *figure 30*)
- Fill the container with 2-3 kg of pellets
- Activate the **Charge Pellet** option (see *chapter 5.9.3.*) → pellet feeder starts to dosing pellets continuously
- Log the dosage start time and allow the pellet feeder to operate for exactly 5 minutes
- After that, remove the pellets from the burner pot and weigh them on the kitchen scale
- If the pellet quantity deviates from the default factory setting (*table 12*), it is necessary to undertake dosage correction +/-



Table 12

| Pellet quantity at stove | | Dosage correction |
|--------------------------|--------------------------|-------------------------------------|
| <i>models by 2017</i> | <i>models after 2017</i> | |
| >540 g | >350 g | Reduce the dosage (e.g. -2) |
| 500 – 540 g | 320 – 350 g | +/- 0 (no correction needed) |
| <500 g | <320 g | Increase the dosage (e.g. +2) |



PELLET DOSAGE DEFAULT FACTORY SETTING IS FOR NOMINAL STOVE POWER, WHICH IS ALSO THE MAXIMUM POWER! THE CUSTOMER IS NOT ALLOWED TO EXCEED THE NOMINAL POWER!!!

In case of any problems in stove operations caused by pellet quantities (too much or too little), **you can regulate pellet dosage directly on the control panel.** The problems can be subdivided into two categories:

INSUFFICIENT FUEL

- the stove is not capable of developing suitable flame which is weak even when the stove is set to maximum heating power

- on minimum power, the flame has a tendency of extinguishing and **A02 alarm occurs** (see chapter 5.12.)

EXCESSIVE FUEL

- the stove develops a strong flame even when it is set to minimum heating power
- the glass becomes stained easily and is almost completely dark
- during ignition phase, the flame is smothered in the burner pot and therefore a large amount of smoke is developed in the firebox.

Functions for pellet dosage regulation into the firebox are listed in the following table.

Table 13

| Function | Value |
|---|--------|
| Temporary States Activations (regulating pellet dosage during stove activation – IGNITION) | -5 ÷ 5 |
| Power States Activations (regulating pellet dosage during regular operation – ON) | |

Example:

- **INSUFFICIENT FUEL:** increase the percentage value by 5 % and test the stove with the new alteration for at least half an hour. If the problem is mitigated but not removed, increase for additional 5 %. Repeat the procedure until the problem is removed.
- E.g. +1 → +5% ⇒ for 5% more dosage
 +2 → +10% ⇒ for 10% more dosage
 max. +5 → +25% ⇒ for 25% more dosage
- **EXCESSIVE FUEL:** use the same principle as in case of insufficient fuel, with the difference of reducing the dosage for a certain percentage (max. 25% lesser dosage)!
- E.g. -3 → -15% ⇒ for 15% less dosage



5.9.3. PELLET FEEDER FILLING (*CHARGE PELLETS*)



This option is available **only if the stove is turned off**, and its purpose is pellet dosage into the firebox (see *figure 30*).

5.9.4. BURNER POT CLEANING (*CLEANING*)



This option is available **only if the stove is turned off**. The flue gases suction ventilator is set to its maximum speed to blow away ash and soot from the burner pot.



The stove is also equipped with a function that allows **automatic cleaning of the burner pot** after a certain period of pellets burning. This process can be recognized by a big and noisy flame. **After a few seconds the stove will continue to operate normally.**

5.10. TECHNICAL MENU (*SERVICE*)

The sole **purpose** of this menu is **servicing** and it includes all the **data** that **can be altered exclusively by authorised technical personnel**. Access to this menu is protected by a password.



After 2000 working hours on the display will appear the message "**Warning**" OR "**Service**" which means that it **is necessary to make a complete service on the stove** (at user's expense) ⇒ from the service technician you must get a "*Certificate of executed stove service.*"



NOTE: If after the appearance of this message you don't call the authorized technical staff, you will lose the warranty on the product!

5.11. USER INFO MENU

This menu (displayed as **User Info** on the control panel) includes **the list of values and functions related to the stove operations control**. None of the displayed values can be altered!

The bottom line of the menu indicates the denomination of the displayed value. Arrow keys allow browsing through various data in the menu. The following table lists different data in the menu in order of their appearance with their available values.

Table 14

| Function | Value |
|---------------------|-----------------------|
| Control Board Code | 000000 |
| Security Code | 000000 |
| Display Code | 000000 |
| Functioning Time | 000000 – 999999 hours |
| Service Time | 0000 – 9999 hours |
| Service | (phone number) |
| Fumes Extractor* | 0000 – 2750 rpm |
| Measured Airflow* | 000 – 400 lpm |
| Fumes Temperature* | 000 – 300°C |
| Pellet Feeder Time* | 0.1 – 12 sec |
| Activation Fan1* | 0 - 30 |

* depending on the current operation of the pellet stove

Very important data which service technician can ask you for, after some “Warning” or “Alarm A0x” appearance on the control panel.

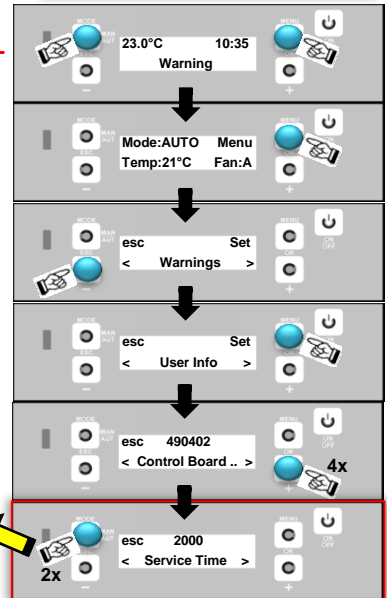

START screen

5.12. ALARMS

When an alarm condition occurs, alarm is displayed on the control panel display (figure 38) ⇒ **the stove automatically shuts down**. In this situation, **it is not possible to access the start menu**, and the stove status cannot be altered **before issuing an order to unblock the alarm**.



The bottom line on the display indicates alarm name and type. **On/Off key stops the alarm sound, and if pressed longer than 2 seconds, the alarm will be unblocked (RESET), but only if alarm cause is removed.**



After pressing the **Info** key a short description of the problem and the information on how to remove it appear on the display. **Esc** key will return you to the previous screen. If no other key is pressed within 60 seconds, the display returns to the start screen.

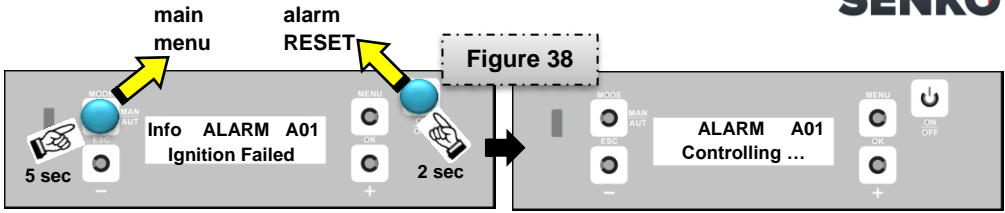

If you **press the Info** (see figure 38) **key longer than 5 seconds**, while the alarm screen is displayed, **you access the main menu** where you can correct the potential errors.

Table 15

| Code | Alarm type | Informations |
|------|--|--|
| A01 | Ignition Failed <ul style="list-style-type: none"> - default factory setting prerequisites for regular ignition not met - pellet tank is empty - burner pot is polluted or wrongly set into the casing - igniter does not heat up - pellet feeder is clogged | <ol style="list-style-type: none"> 1. <u>reset the alarm</u> and restart 2. check the pellet level in the tank 3. empty the tank and clean the pellet feeder spiral 4. check if the burner pot is properly set and cleaned – read <i>Chapter 6.1</i>. 5. turn on the stove and check if the igniter heats |
| A02 | Flame Shut Down <ul style="list-style-type: none"> - pellet feeder “running dry” or clogged - lack of fuel in the firebox - flue gases fan excessive speed OR too low flue gases temperature | <ol style="list-style-type: none"> 1. <u>reset the alarm</u> and restart 2. check the pellet level in the tank 3. clean the pellet feeder spiral 4. fill the pellet tank 5. see <i>chapter 5.9.2</i>. 6. technician must reduce the fan speed OR increase the temperature |
| A03 | Pellet Tank Over-Temp. <ul style="list-style-type: none"> - stove body overheating - stove operating on maximum power too long or is poorly ventilated, i.e. warm air fan operates on too low speed | <ol style="list-style-type: none"> 1. <u>reset the alarm</u> and restart 2. reduce the stove heating power and increase warm air fan speed 3. clean the central flue gases channel according to <i>chapter 6.7</i>. |
| A04 | Fumes Over-Temperature <ul style="list-style-type: none"> - stove body overheating - stove operating on maximum power too long or is poorly ventilated, i.e. warm air fan operates on too low speed | <ol style="list-style-type: none"> 1. <u>reset the alarm</u> and restart 2. reduce the stove heating power and increase warm air fan speed 3. clean the central flue gases channel according to <i>chapter 6.7</i>. and the plate in the firebox-Fig.46c and <i>d</i> |
| A05 | Fumes Pressure Switch Alarm <ul style="list-style-type: none"> - flue gas channels or chimney clogged - chimney diameter larger than prescribed | <ol style="list-style-type: none"> 1. <u>reset the alarm</u> and restart 2. repeat ignition 4-5 times 3. while the stove is shutting down (flue gases fan rotating at maximum speed), burn some paper and put a fistful of pellets into the firebox to warm the chimney |

| | | |
|------------|---|--|
| | <ul style="list-style-type: none"> - firebox door open or the seal damaged - pellet feeder spiral clogged - improperly executed installation (chimney not properly sealed) - chimney is not insulated according to the instructions - burner pot improperly installed into the casing | <ol style="list-style-type: none"> 4. check and clean the chimney and flue gas channels 5. connect the stove to a chimney with prescribed diameter 6. check the firebox door and replace the gasket 7. remove all the pellets from the tank and clean the pellet feeder spiral 8. properly set the burner pot into the casing |
| A06 | Combustion Airflow Alarm | <ol style="list-style-type: none"> 1. <u>reset the alarm</u> and restart 2. check burner pot cleaning / air intake / chimney |
| A07 | Door Open <ul style="list-style-type: none"> - uncontrolled entry of air into the firebox - flue gas channels or chimney clogged - airflow sensor is polluted | <ol style="list-style-type: none"> 1. <u>reset the alarm</u> and restart 2. check if door is closed and replace the door gasket if necessary 4. check and clean the chimney and central flue gas channel - <i>chapter 6.7.</i>; clean the sensor - <i>chapter 6.9.</i> |
| A08 | Fumes Extractor Error | <ol style="list-style-type: none"> 1. <u>reset the alarm</u> and restart 2. check and clean the chimney and central flue gas channel - <i>chapter 6.7.</i> |
| A09 | Fumes Temp. Sensor Error | <ol style="list-style-type: none"> 1. <u>reset the alarm</u> and restart 2. too low temperature of the surrounding area 3. contact an authorized technician |
| A10 | Pellet Igniter Error | <ol style="list-style-type: none"> 1. <u>reset the alarm</u> and restart 2. contact an authorized technician |
| A11 | Pellet Feeder Error | <ol style="list-style-type: none"> 1. <u>reset the alarm</u> and restart 2. contact an authorized technician |
| A13 | Electronic Motherboard Error <ul style="list-style-type: none"> - motherboard overheating | <ol style="list-style-type: none"> 1. <u>reset the alarm</u> and restart 2. reduce the stove heating power and increase warm air fan speed |
| A18 | Water tank over-temperature <ul style="list-style-type: none"> - stove operating on maximum power too long or is poorly ventilated, i.e. warm air fan operates on too low speed - system is oversized, improperly performed installation of central heating - too small water flow - pump rotor is blocked - too much fuel in the firebox - radiators closed or not properly deaerated | <ol style="list-style-type: none"> 1. <u>reset the alarm</u> and restart 2. reduce the stove heating power and increase warm air fan speed 3. dimension the central heating system according to professional standards and DIN 4751 norm – part 1 for open systems, i.e. DIN 4751 – part 2 for closed systems 4. increase water flow by adjusting the pump speed 5. unblock (clean) the pump rotor according to <i>chapter 4.6.1.</i>, point 3 6. make sure that all the radiators are opened and well deaerated |

6. CLEANING AND MAINTENANCE



Never undertake cleaning and maintenance procedures until the stove is completely cold and turned off!



Recommended cleaning and maintenance intervals of SENKO pellet stoves are listed in the *Table 16*.

The stove does not require excessive maintenance provided you use high-quality, certified pellets (see chapter 2)!

6.1. BURNER POT

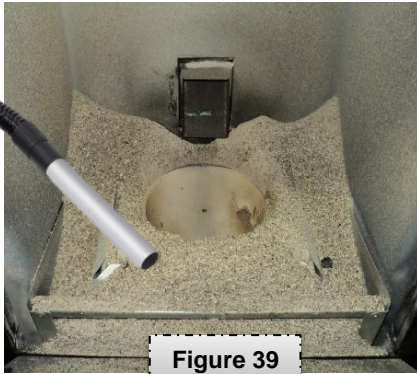

Figure 39

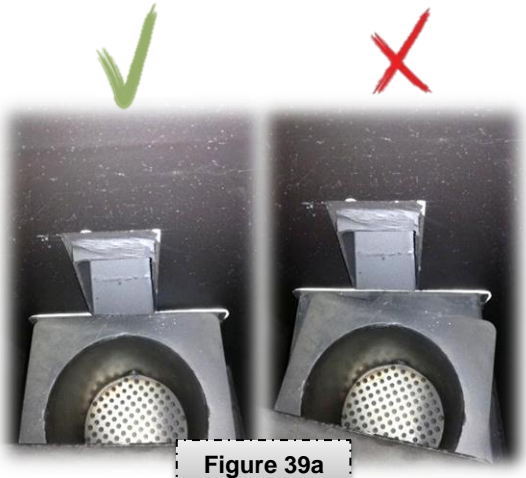

Figure 39a



Prior to every stove activation use appropriate tool to remove the burner pot from the firebox and use a vacuum cleaner with a container to **remove the ash in the burner pot and below the burner pot.**



It is important that the ash is completely cold during vacuuming!

A properly cleaned burner pot guarantees proper functioning of the stove. Should you, during burner pot feeding phase, notice that apart from pellets, **a lot of sawdust and dust is falling into the burner pot**, you must clean the pellet tank as soon as possible. Otherwise, **dangerous backfire towards the pellet tank may occur**. If the described situation occurs again



after you have cleaned the tank, it means you are using low quality pellets.
Use pellets described in *chapter 2!*

Once a day (depending on pellet quality – ash content) BE SURE TO clean the burner pot, otherwise, dangerous backfire towards the pellet tank or clogging of the pellet feeder pipe may occur, which eventually leads to damages to the dosage system!



Every time you remove the burner pot, make sure you properly install it back into the casing - OBLIGATORY CHECK THAT THE IGNITER TUBE OVERLAPS WITH THE HOLE ON THE LOWER PART OF THE BURNER POT – see *Figure 39a!*



It is also possible, depending on the pellet type and quality, that solid ash deposits accumulate and stick around or on the pot. These must be cleaned *if necessary* using appropriate tools! **All holes in the burner pot must be clean and passable!**



IN CASE OF WEAR-DOWN OR DAMAGE, IMMEDIATELY REQUEST AN AUTHORIZED MAINTENANCE TECHNICIAN TO REPLACE YOUR BURNER POT (REPLACEMENT IS NOT COVERED BY WARRANTY SINCE THIS IS A MATERIAL PRONE TO WEARING DOWN).

6.2. ASH PAN

Perform the ash pan cleaning **every 2-3 days** also, depending on the pellet type, i.e. the quantity of produced ash.

Perform the procedure **with a vacuum cleaner with a container, only if the ash is cold.**

Once you have performed the cleaning, **properly put the ash pan back into the casing frame!**



Figure 40

IN CASE OF WEAR-DOWN OR DAMAGE, IMMEDIATELY REQUEST AN AUTHORIZED MAINTENANCE TECHNICIAN TO REPLACE YOUR ASH PAN (REPLACEMENT IS NOT COVERED BY WARRANTY SINCE THIS IS A MATERIAL PRONE TO WEARING DOWN).

6.3. DOOR GLASS

Firebox door are equipped with fire resistant glass (750°C). The glass is, regardless of the high resistance to heat, sensitive to impact force.

The glass is self-cleaning, i.e., during regular stove operation, a light air current touches the inner surface of the glass, significantly reducing ash and dirt deposits.

If necessary, **clean the channel behind the sheet metal** (marked in the picture) so that the air required for glass cleaning has its own function.

It is possible for glass to become stained during several hours of regular stove operation, **depending on used pellet type and chimney underpressure**. In that case **clean the glass using a cotton cloth, newspaper or a dishtowel** moisturized with a glass cleaning liquid (*figure 41*).

Make sure to perform the described procedure only while the stove is cold.



Figure 41

6.4. EXTERNAL SURFACE

Use a **soft cloth with neutral cleaning liquid** for cleaning.

Never use metallic sponges and/or similar sponges, lest you damage the surface!

PAINTED SURFACES DO NOT CLEAN WITH ABRASIVE CLEANING AGENTS!



6.5. PELLET TANK



Periodically (**at least once a month**) completely empty the pellet tank (by using a vacuum cleaner) - **vacuum the dust and sawdust that has accumulated inside!**

Figure 42

6.6. FIREBOX DOOR GASKET

The seal guarantees that the stove is hermetically sealed, and consequently, proper stove functioning. **Be sure to periodically control it** – in case of wear-down or damage, it needs to be replaced by an authorized individual.

6.7. CENTRAL FLUE GAS CHANNEL

If don't, alarm A07 or A04 will occur!!!

Central flue gases channel must be cleaned once a month because the accumulated soot clogs the normal flow of flue gases. Unscrew the bolts to **remove the plate located under the firebox**. Use the vacuum cleaner to clean the combustion residues accumulated at the bottom of the channel.

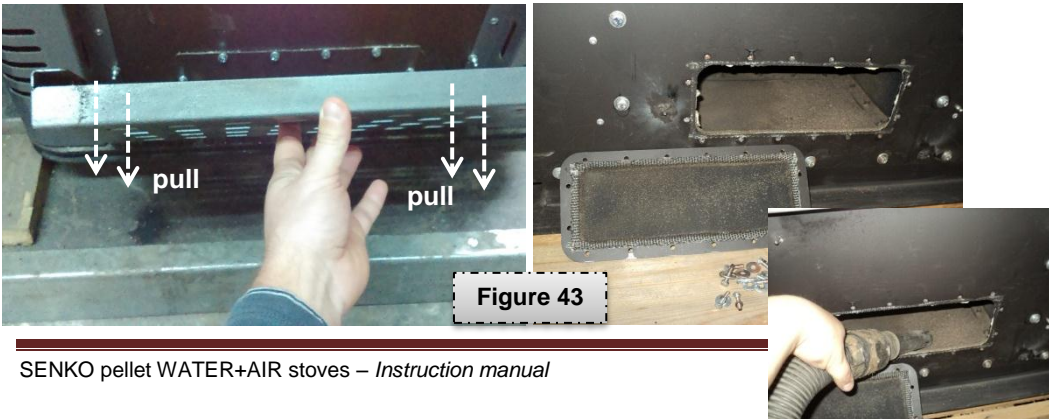

Figure 43

It is also necessary to **remove the upper stove lid**, and by **unscrewing the bolts remove the plate located under the lid**, then **remove the *turbulators* (spirals)** and properly clean them with a brush.



a)



b)



d)

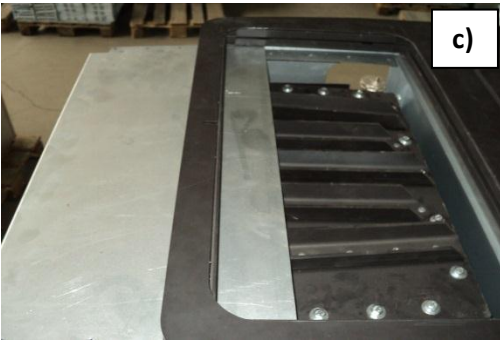

c)

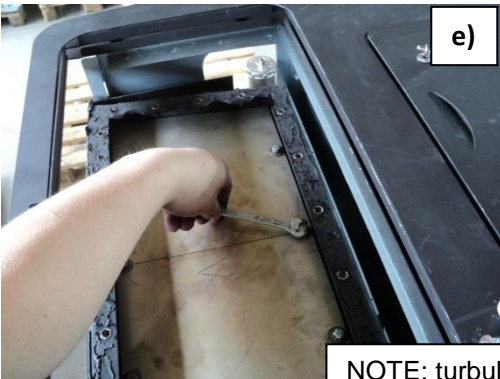

e)



f)

Figure 44

NOTE: turbulators are located only on some models of pellet stoves ⚠

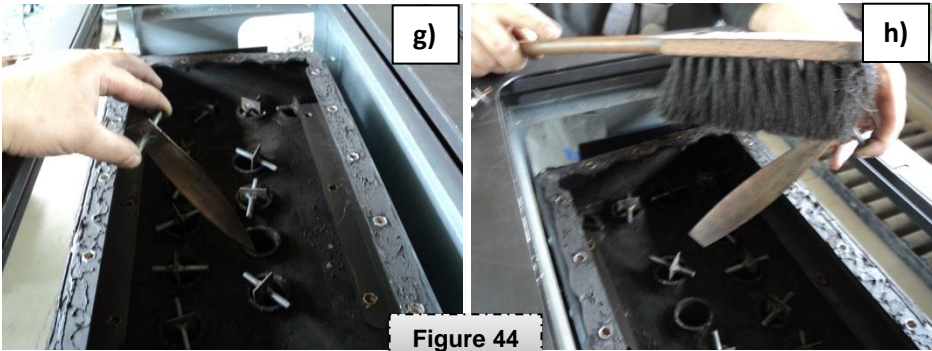

Figure 44



i)

After cleaning, it is necessary to assemble everything in reverse order.
In places where it was a gasket (or silicone sealant), it is necessary to put the new one (heat-resistant) to ensure a good seal!

When cleaning the upper side of the stove, and if the firebox door or the lid under the firebox is opened, it is possible that a fine ash comes out from the tubes! ⚠

6.8. OUTPUT FLUE GAS CHANNEL

At the beginning of every heating season clean the flue gases output channel, i.e. the chimney. **The chimney must be regularly maintained by an authorized individual** in order to ensure proper stove functioning. Skipping the annual chimney maintenance is grounds for cancelling product warranty.



6.9. INPUT PRIMARY AIR CHANNEL

Figure 45

At the beginning of every heating season (and may also more frequently) control the primary air inlet channel (Ø 50 mm on the stove backside) for clogging with foreign objects.

Check and wipe the **airflow sensor** (15 on figure 2) – see the arrows on the sensor!

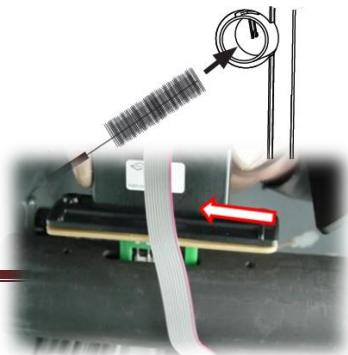

Clean the sensor when an alarm A07 occurs! ⚠

6.10. FIREBOX

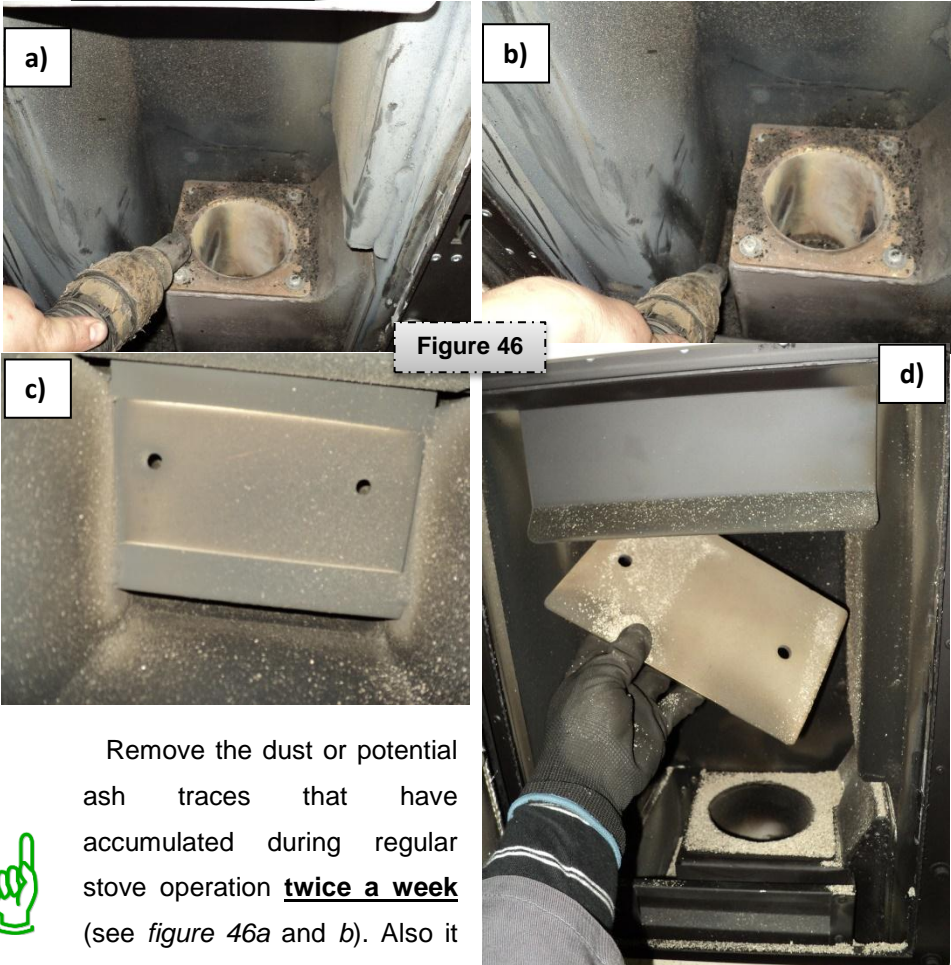
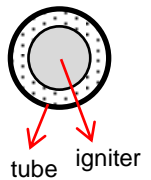

Figure 46

Remove the dust or potential ash traces that have accumulated during regular stove operation **twice a week** (see figure 46a and b). Also it is necessary to **remove and**

clean the plate in the firebox (see figure 46c and d). The plate (5) is shown in figure 2. **If don't, alarm A04 will occur!!!**

It is also important to occasionally clean **ash residue between igniter support tube and igniter** which is located in the firebox within the burner pot. It is important to enable free circulation of air around the igniter, which prevents the igniter from burning out.



Igniter must always be placed in the middle of the supporting tube!

6.11. ELECTRONIC COMPONENTS

We recommend **annual inspection of all electronic components by an authorised individual**. The inspection consists of visual and functional inspection of internal stove parts (motors, safety devices and similar) and their replacement if necessary.



During periods of inactivity the stove must be unplugged and located in a dry environment. To ensure even higher level of safety, we recommend to disconnect the electric cable from the stove and store it in a safe location.



Should you, during stove reactivation, fail to turn the stove on, it is possible that the fuse (max 6,3A and 250 V) located on the switch at the stove backside has blown. In that case, it is necessary to replace it by using the screwdriver to **pull out the plastic part in the centre of the switch** and to remove the fuse (*figure 47*).

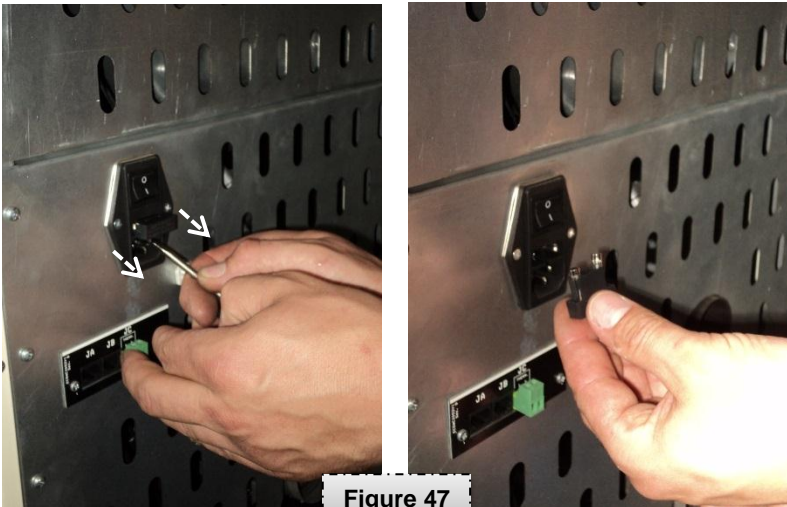

Figure 47



Recommended cleaning and maintenance intervals of SENKO pellet stoves are listed in the following table.

| PART | CLEANING AND MAINTENANCE INTERVAL | | | |
|--|-----------------------------------|----------|---------|--------|
| | 1 day | 2-3 days | 30 days | 1 year |
| Burner pot (see chapter 6.1.) | ✓ | | | |
| Ash pan (see chapter 6.2.) | | ✓ | | |
| Door glass (see chapter 6.3.) | | ✓ | | |
| Firebox (see chapter 6.10.) | | ✓ | | |
| Pellet tank (see chapter 6.5.) | | | ✓ | |
| Heat exchanger – boiler (see chapter 6.7.) | | | ✓ | |
| External surfaces (see chapter 6.4.) | | | ✓ | |
| Central flue gases channel + turbulators (see chapter 6.7.) | | | ✓ | |
| Igniter support tube (see chapter 6.10.) | | | ✓ | |
| Input primary air channel (see chapter 6.9.) | | | | ✓ |
| Output flue gas channel – chimney (see chapter 6.8.) | | | | ✓ |
| Ventilator and pellet feeder motors, pump and other electronic equipment | | | | ✗ |

✗ these actions of cleaning and maintenance can be performed only by authorized personnel of pellet stove producer

NOTE: The actions listed in the table above can be performed even more frequently (if necessary), depending on the quality of pellets that you use!



7. MALFUNCTIONS / CAUSES / SOLUTIONS

All potential repairs must be executed exclusively by an authorised individual while the stove is cold and unplugged!



| PROBLEM | POSSIBLE CAUSE | SOLUTION |
|--|--|---|
| Pellets are not inserted into the firebox | <ul style="list-style-type: none"> ◆ pellet tank is empty ◆ pellet feeder is blocked with sawdust or foreign bodies ◆ pellet feeder motor is malfunctioning ◆ defective motherboard | <ul style="list-style-type: none"> ⇒ fill the pellet tank ⇒ empty the pellet tank and manually clean the pellet feeder spiral and the dosing tube. After cleaning, check the dosage according to <i>figure 30</i>. ⇒ check the motor and replace it if necessary ⇒ check the motherboard and replace it if necessary |
| The fire is extinguished or the stove ceases operation with no reason | <ul style="list-style-type: none"> ◆ pellet tank is empty ◆ pellets are not inserted into the firebox ◆ alarm is appeared on the control panel ◆ timer (<i>chrono</i>) is active ◆ firebox door is not properly closed or the gasket is damaged ◆ pellets used do not meet the criteria for proper stove functioning ◆ improper pellet dosage ◆ firebox polluted ◆ primary air inlet channel clogged ◆ chimney clogged ◆ flue gases ventilator motor malfunctioning | <ul style="list-style-type: none"> ⇒ fill the pellet tank ⇒ see previous problem ⇒ allow the stove to cool completely, reset the alarm (see <i>chapter 5.12</i> and <i>Table 15</i>) and repeat stove ignition process ⇒ check timer activation ⇒ close the door or replace the gasket with a new original ⇒ replace the pellet type with one recommended in <i>chapter 2</i>. ⇒ correct dosage according to <i>chapter 5.9.2</i>. ⇒ clean the firebox according to <i>chapter 6.10</i>. ⇒ clean primary air intake pipe (∅ 50 mm) according to <i>chapter 6.9</i>. ⇒ clean the chimney ⇒ check the motor and replace it if necessary |
| The stove works for a few minutes and then shuts down | <ul style="list-style-type: none"> ◆ activation sequence not completed ◆ chimney clogged ◆ alarm is appeared on the control panel ◆ combustion air supply inadequate ◆ temporary failure of electricity supply ◆ pellet igniter malfunctioning | <ul style="list-style-type: none"> ⇒ repeat stove ignition process ⇒ clean the chimney ⇒ allow the stove to cool completely, reset the alarm (see <i>chapter 5.12</i> and <i>Table 15</i>) and repeat stove ignition process ⇒ clean primary air intake pipe (∅ 50 mm) according to <i>chapter 6.9</i>. ⇒ when electricity is restored, the stove will be cooled down and switched off; repeat stove ignition ⇒ check the igniter and replace it if necessary |
| Pellets accumulate in the burner pot, the | <ul style="list-style-type: none"> ◆ insufficient combustion air | <ul style="list-style-type: none"> ⇒ clean primary air intake pipe (∅ 50 mm) according to <i>chapter 6.9</i>. |

| | | |
|--|---|---|
| <p>flame is weak and the glass stains</p> | <ul style="list-style-type: none"> ◆ holes on the burner pot bottom are clogged ◆ firebox door gasket is damaged ◆ moist and inadequate pellets ◆ chimney clogged or is not installed according to instructions ◆ flue gases ventilator motor malfunctioning | <p>⇒ clean the burner pot and entire firebox</p> <p>⇒ check the door gasket and replace it if necessary</p> <p>⇒ replace the pellet type with one recommended in <i>chapter 2</i>.</p> <p>⇒ clean the chimney and check if it is installed according to instructions</p> <p>⇒ check the motor and replace it if necessary</p> |
| <p>Flue gases suction ventilator does not work</p> | <ul style="list-style-type: none"> ◆ no power supply to the stove ◆ motor malfunction ◆ motherboard malfunction | <p>⇒ check the power supply cable and the fuse on the switch at the backside of the stove</p> <p>⇒ check (and clean) the motor and replace it if necessary</p> <p>⇒ replace the motherboard</p> |
| <p>Warm air ventilator works continuously</p> | <ul style="list-style-type: none"> ◆ fumes temperature probe malfunction ◆ ventilator malfunction | <p>⇒ check and replace the probe if necessary</p> <p>⇒ check the motor and replace it if necessary</p> |
| <p>The remote control does not work</p> | <ul style="list-style-type: none"> ◆ battery empty ◆ remote control malfunction | <p>⇒ replace the battery</p> <p>⇒ replace the remote control</p> |
| <p>In automatic mode the stove always operates on maximum power</p> | <ul style="list-style-type: none"> ◆ temperature is set to maximum ◆ room/water temp. probe malfunction ◆ control panel malfunction | <p>⇒ reduce the temperature on the control panel or the thermostat</p> <p>⇒ check and replace the probe if necessary</p> <p>⇒ check and replace the control panel if necessary</p> |
| <p>The stove cannot be turned on</p> | <ul style="list-style-type: none"> ◆ electric power supply to the stove reduced ◆ fuse blown | <p>⇒ check if the electric cable is connected to the stove backside and if the switch is in „I“ position</p> <p>⇒ replace the fuse (<i>figure 47</i>)</p> |
| <p>Pellets do not ignite</p> | <ul style="list-style-type: none"> ◆ burner pot polluted ◆ burner pot is not properly installed into the casing ◆ chimney and/or flue gas channels clogged ◆ pellet igniter does not heat up | <p>⇒ clean the burner pot from ash and unburned pellet residue</p> <p>⇒ check and properly set the burner pot into the casing – see <i>figure 39a</i></p> <p>⇒ clean the chimney and/or flue gas channels according to <i>chapter 6.7</i>.</p> <p>⇒ check and replace the igniter if necessary</p> |
| <p>There is noise from the boiler</p> | <ul style="list-style-type: none"> ◆ insufficient water level in the central heating system ◆ insufficient water pressure in the central heating system ◆ improper central heating installation ◆ excessive water flow | <p>⇒ refill the system with necessary amount of water to achieve 1 bar</p> <p>⇒ increase water pressure to 1 bar</p> <p>⇒ execute the central heating installation in accordance with professional standards and DIN 4751 norm - part 1 for open systems, i.e. 4751 - part 2 for closed systems</p> <p>⇒ reduce the water flow by adjusting</p> |

| | | |
|--|--|---|
| | in the system ♦ air in the system | the number of pump rotations ⇒ deaerate the system properly |
| Water leaking from the boiler (boiler condensation) | ♦ excessive water flow ♦ fuel too moist ♦ too low water return temperature ♦ boiler damaged | ⇒ reduce the water flow ⇒ use fuel as described in <i>chapter 2</i> . ⇒ it is mandatory to install the 3-way thermostat mixing valve ⇒ call an authorized maintenance technician |
| Outlet boiler water does not reach the required temperature | ♦ central heating system improperly dimensioned ♦ boiler is contaminated ♦ insufficient heating power ♦ pump blocked ♦ radiators are not properly deaerated ♦ probe that measures the water temperature does not show the correct temperature | ⇒ dimension the central heating system according to professional standards and DIN 4751 norm – part 1 for open systems, i.e. DIN 4751 – part 2 for closed systems ⇒ check and clean the boiler ⇒ increase the stove heating power ⇒ adjust the water flow in accordance with the boiler thermal possibilities ⇒ clean the pump according to <i>chapter 4.6.1.</i> , point 3 ⇒ deaerate the radiators properly ⇒ replace the probe if necessary |

- **Procedures marked with bold must only be executed by personnel authorized by the manufacturer!**
- **Manufacturer bears no responsibility in case of failure to adhere with these procedures!**



8. TECHNICAL SUPPORT

Dear client,

If you were unable to find the solution to the malfunctions, that potentially developed while using your product, in the table above and *table 15*, please feel free to contact our complaint and support service:

- Tel: 00385 40 337 344
- Fax: 00385 40 337 906
- E-mail: info@senko.hr, podrska@senko.hr

WE'D LIKE TO TAKE THIS OPPORTUNITY TO REMIND YOU WHAT YOU NEED TO POSSES WHEN CONTACTING OUR COMPLAINT AND SUPPORT SERVICE:

Before you contact us, prepare the following documents:



- **purchase receipt with the date of purchase,**
- **warranty** (*at the back of this Manual*),
- **written installation report** (*at the back of this Manual*)
- **Instruction manual.**

The documents listed above are necessary to ensure the quickest and clearest removal of the occurring malfunction!

9. TECHNICAL DATA

| SENKO pellet stove for central heating | P 12 WATER+AIR | P 12 SLIM WATER+AIR | P 20 WATER+AIR |
|---|----------------|---------------------|----------------|
| Height, mm | 1135 | 1155 | 1260 |
| Width, mm | 600 | 975 | 660 |
| Depth, mm | 680 | 405 | 680 |
| Weight, kg | 220 | 190 | 260 |
| Primary air intake, mm | Ø 50 | | |
| Flue gases exhaust, mm | Ø 80 | | |
| Nominal power (P _{nom}), kW | 13 | 13 | 19 |
| Boiler, kW | 11,5 | 11,1 | 16,7 |
| Room, kW | 1,5 | 1,9 | 2,6 |
| Minimal power (P _{min}), kW | 6,9 | 7 | 8,8 |
| Boiler, kW | 5,2 | 5,3 | 6,9 |
| Room, kW | 1,7 | 1,7 | 1,9 |
| Amount of water in boiler, L | 30,5 | 28 | 35 |
| Operating pressure (max), bar | 2,5 | | |
| Operating temperature, °C | 80 | | |
| Fuel consumption at P _{nom} *, kg/h | 2,8 | | 4,2 |
| Fuel consumption at P _{min} *, kg/h | 1,5 | | 1,9 |
| Tank capacity, kg | 34 | 24 | 54 |
| Efficiency at P _{nom} , % | 94,95 | 94,17 | 94,53 |
| Efficiency at P _{min} , % | 94,64 | 96,13 | 96,21 |
| Necessary chimney draught, Pa | 12 | | |
| Emiss. of CO at P _{nom} (13% O ₂), % | 0,0069 | 0,007 | 0,0027 |
| Emiss. of CO at P _{min} (13% O ₂), % | 0,0146 | 0,014 | 0,0061 |
| Flue gas temperature at P _{nom} , °C | 77 | 92 | 93 |
| Flue gas temperature at P _{min} , °C | 63 | 64 | |
| Flue gas mass flow at P _{nom} , g/s | 12,2 | 10,7 | 14,7 |
| Autonomy (operating time between re-fuelling) at P _{nom} *,h | 12,5 | 8,6 | 12,9 |
| Autonomy (operating time between re-fuelling) at P _{min} *,h | 23,3 | 16 | 28,4 |
| Electric energy consumption during activation, W | 340 | | |
| Average electric energy consumption**, W/h | 130 | | 160 |
| Supply voltage and frequency | 230 V / 50 Hz | | |

*variable data; may vary depending on the type of pellets used

**variable data; may vary depending on the stove operating conditions

- Technical specifications refer to use of pellets with quality ENplus-A1 and net calorific value of 4,9 kWh/kg
- Technical specifications are indicative and variable as such. The manufacturer reserves the right to alter any technical specification for the purposes of product improvement

10. TERMS OF WARRANTY

These terms of warranty are valid in all European countries where SENKO products are sold. The client addresses the vendor or the nearest authorized servicing agent for all complaints; providing the purchase receipt with the date of purchase, warranty sheet and installation report in the process.

WARRANTY DURATION

Manufacturer provides a **2 year** warranty for this product, starting from the date of purchase for all errors in production or construction materials. Electric and electronic components have a **1 year warranty**.

The manufacturer guarantees that the product was manufactured and certified according to the EN 14785:2006 norm and that it complies with all the demands set by the norm. The user is obligated to adhere to the Instruction manual.

PARTS NOT COVERED BY THE WARRANTY

All parts susceptible to wear-down like vermiculite plates, burner pot, seals, glass, ash pan, electric cables, plasticized or ceramic parts and all the parts that can be removed from the firebox are an exception.

Vermiculite plates (possible discoloration and cracks). However, these changes do not compromise proper functioning of the product (as long as the plates are in the firebox) and they are not a motive for complaint.

Glass (glass breakage due to external influences and surface changes due to heat influences like flying ash or soot).

Changes in original colour of the materials due to high temperature conditions.

Seals (e.g. hardening or breaking due to heat or mechanic influences).

Material surfaces (frequent cleaning or cleaning with abrasive cleaning agents).

Parts exposed to excessive thermal influences such as the burner pot, ash pan and the grid (the upper protective sheet) for warm air expulsion.

Heat exchanger (boiler) is not subject to the warranty in the event in which it is not secured with adequate anti-condensate circuit which guarantees a minimum return water temperature of at least 55°C.

REPAIRS

Possible repairs within the warranty will be executed within 30 days from the date of product delivery to the manufacturer. Should the repairs not be executed within 30 days from the delivery to the manufacturer, the product will be replaced with a new one. The manufacturer will notify the client about the executed repairs. The client is obligated to take over the product within 5 days from the repair completion.

EXPENSES

The manufacturer does not defray any delivery and return costs.

Prior to commencement of repairs within the warranty (for damages caused by incorrect use, stove transport and mounting), the manufacturer will notify the client about the repair price in written form. Once the client agrees, the manufacturer will execute the repairs and charge the client for the repairs.

REPLACEMENT PARTS

Original parts replaced within the warranty do not have to match the removed parts in external physical appearance, but they must match them in quality and functionality.

DISCLAIMER

The manufacturer is not responsible for product loss or damages due to theft, fire, vandalism or similar causes. Direct or indirect damages to the product resulting from inadequate transport are not covered by this warranty. The manufacturer is also not responsible for damages caused by chemical or electrochemical effects (harmful substances in the combustion air, water limescale and similar) resulting from improper product installation and failure to adhere to the Instruction manual.

ADDITIONAL TERMS

Small dimensional differences in construction materials and parts of the stove are not a reason for complaint. During the period in which the product was inefficient, we will not grant any compensation. This warranty applies only to the customer specified in the warranty sheet and cannot be transferred to others.

The warranty is void if the user has made any alterations to the product without notifying the manufacturer. If the user was negligent and performed maintenance on the wrong way. If the user is using fuel that is not compliant with the types and quantities indicated in this Manual.

The warranty is valid only if the product was installed by an authorized expert, and only with written installation report.

Possible disputes to be settled by the competent Court in Čakovec.

WARRANTY SHEET No.

PELLET STOVE FOR CENTRAL HEATING:

- P 12 WATER+AIR / E2404 P 12 SLIM WATER+AIR / E2406
 P 20 WATER+AIR / E2405

SERIAL NUMBER: _____

DATE OF MANUFACTURE: _____

STORE NAME
AND ADDRESS: _____
_____CLIENT NAME
AND ADDRESS: _____

DATE OF PURCHASE: _____

STORE STAMP AND
VENDOR SIGNATURE: _____Faulty product date of receipt:
_____Malfunction description (client):

_____Servicing agency comments:

_____Servicing completed:

date

Stamp and servicing technician
signature: _____Faulty product date of receipt:
_____Malfunction description (client):

_____Servicing agency comments:

_____Servicing completed:

date

Stamp and servicing technician
signature: _____

COMPLETED BY THE CHIMNEY-SWEEPER**Chimney connection executed by the company:**Company/Business: _____ Person in charge: _____
stamp and signature

Street: _____ City: _____

Telephone: _____ Country: _____

Date: _____ Client signature: _____

Chimney

Type:

Dimensions (mm):

Height (m):

Draft (Pa):

Flue gases exit temperature (°C):

Last inspection date:

Number of connections:

Smoke venting pipe (if connected)

Cross-section (mm):

Length (m):

Number of elbows:

COMPLETED BY THE CENTRAL HEATING INSTALLATION CONTRACTOR**Central heating system connection executed by the company:**Company/Business: _____ Person in charge: _____
stamp and signature

Street: _____ City: _____

Telephone: _____ Country: _____

Date: _____ Client signature: _____

Open system yes noClosed system yes no

Connection execute in accordance with DIN 4751 yes no

Heated space volume (m³):Expansion tank volume (m³):Pump type: Water flow (m³/h):

Safety valve type: Safety valve approved atbar

Water temperature (°C) ⇒ inlet: ⇒ outlet:



Senko d.o.o.
 Vladimira Nazora 22, Štefanec
 40 000 Čakovec, Republic of Croatia
 14

EN 14785:2006

Stove for wood pellets

| | P 12 WATER+AIR | P 12 SLIM WATER+AIR | P 20 WATER+AIR |
|--|--|--------------------------------|---------------------------|
| Minimum distance from flammable surfaces : | above 100 cm front 150 cm rear 20 cm sidebar 20 cm | | |
| Nominal output (P_{nom}) : | 13 kW | 13 kW | 19 kW |
| Minimal output (P_{min}) : | 6,9 kW | 7 kW | 8,8 kW |
| Flue gases temperature : | 77°C | 92°C | 93°C |
| CO emission in flue gases (by 13% O₂) at P_{nom} : | 0,0069 % | 0,007 % | 0,0027 % |
| CO emission in flue gases (by 13% O₂) at P_{min} : | 0,0146 % | 0,014 % | 0,0061 % |
| Efficiency at P_{nom} : | 94,95 % | 94,17 % | 94,53 % |
| Efficiency at P_{min} : | 94,64 % | 96,13 % | 96,21 % |
| Fuel type : | wood pellets according to ENplus-A1, DIN plus, Ö-Norm M 7135 | | |
| Fuel consumption : | 2,8 kg/h | | 4,2 kg/h |
| Certificate Nr : | E-30-00529-14 | E-30-00530-14 | E-30-00531-14 |

Read and follow the Instruction manual. Use only recommended fuel.

Produced in the EU

DECLARATION OF CONFORMITY

These products are certified in accordance with the EN 14785. Test reports number 30-12031-T-2 (P 12 WATER+AIR), 30-12031-T-3 (P 12 SLIM WATER+AIR) and 30-12031-T-1 (P 20 WATER+AIR) from July 11th, 2014.

NOTES :

*For a perfect
warm home!*



SENKO

Vladimira Nazora 22, Štefanec, 40000 Čakovec, Hrvatska

Tel: +385 (0)40 33 73 44 • E-mail: info@senko.hr

www.senko.hr



*... THE SPIRIT OF TRADITION
IN MODERN FORMS FOR
A HEALTHY ENVIRONMENT.*

facebook.

YouTube



You can find this Manual at <http://en.senko.hr/>

We reserve the right to change all pictures, technical details and colours of products, mentioned in this manual, without prior notice.